

MULTIMEDIA DATA/VIDEO PROJECTORS

The More You Use It... The Clearer the Difference

The ideal assistant for educational environments



NEW Excellent cost-performance and easy to use
XD280U-G/XD250U-G



5 Easy-to-manage Features

Simultaneous Message Display → **Visual PA**

Using a control room computer equipped with projector-control software, administrators can create and send messages (up to 350 characters long) in real-time to projectors connected to the LAN. Ideal for broadcasting important information to multiple rooms on the LAN.

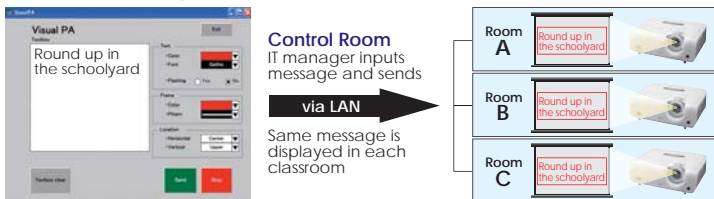

Low Operating Cost → **Standby Mode under 1W⁽¹⁾, 6,000hr⁽²⁾ Long-life Lamp, filter-free**

Low operating cost is realized by integrating energy saving technology into every function. Maintenance cost and frequency have been reduced as well.

Lamp Replacement Frequency⁽³⁾

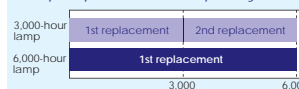

(1): 3W in Normal mode (network turned on).

(2): When used at the low lamp mode. Maximum estimated lamp life at standard mode use is 3,000 hours.

(3): Lamp life refers to the average time required for brightness to be reduced by half, and not the time specified in the warranty. Use time may vary widely by the environment and conditions, and whether or not cleaning and other maintenance procedures are followed.

Simple Lamp Replacement → **Top-loading Lamp**

Whether it's sitting on a shelf or suspended from the ceiling, lamp replacement is simple and easy. With its convenient top access lamp design, there is never a need to move the whole projector.



All-in-one Management of Multiple Projectors → **ProjectorView Global+**

After installing ProjectorView Global+ (separately available software), the status of multiple projectors connected to a dedicated LAN in the same network can be viewed. Remote operation of the power switch (ON/OFF), image input switch and other remote functions are now possible.

Enhanced Terminal group → **HDMI, Dual PC Input**

5 Easy-to-use Functions

Excellent Sound Projection → **10W Speaker + Audio Mix**

The built-in high-volume 10W speaker eliminates the need for an external speaker. By using the "Audio Mix" feature and a wireless microphone (not included), the presenter's voice is amplified loud and clear every time.

^{*}Only compatible with stereo mini-jack.
Not compatible with RCA jack (L/R) or HDMI.

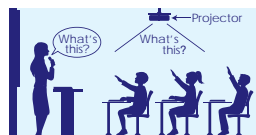

Vastly Improved Operability → **Quick Menu**

For improved operation ease, the tool bar has seven main menus and one custom menu. Switching to the sub-menu allows the selection of more specific operations.



Quiet Fan Noise → **Silent 28dBA Operation (in low mode)**

With the quiet operating level of the XD280U-G/XD250U-G—presenters no longer need to compete with a loud fan for attention from the audience.

Automatic Subtitle Function → **Closed Caption (CC) Capable**

A closed caption decoder comes installed as standard equipment. Words spoken are processed into subtitles that are projected onto the screen. This feature conveniently addresses the needs of language students and hearing-impaired viewers.

Superior Color Performance → **New BrilliantColor™ Adopted**

Mitsubishi Electric's original built-in color wheel is incorporated for enhanced color reproduction. Clear, vivid images are reproduced from both computer and video signals.



NEW



XD280U-G XD250U-G

MOBILE XGA PROJECTOR

- Brilliant Color™
- Color Enhancer
- Wall Screen
- 10W Speaker
- User Logo Projection
- Password Lock
- Instant Shutdown
- Long-life Lamp
- Low Standby Power
- Top/Side Loading Lamp
- LAN (RJ-45)
- HDMI
- Closed Caption
- Low Fan Noise
- Picture Performance
- Presentation
- User Friendly

Input and Output Terminals

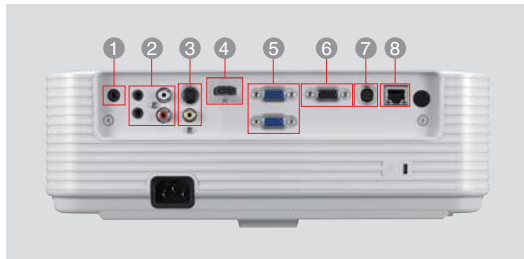

- 1 Audio output
- 2 Audio input
- 3 S-Video/Video
- 4 HDMI
- 5 PC/Component Video input
- 6 Monitor output
- 7 Serial RS-232C
- 8 LAN (RJ-45)

Dimensions

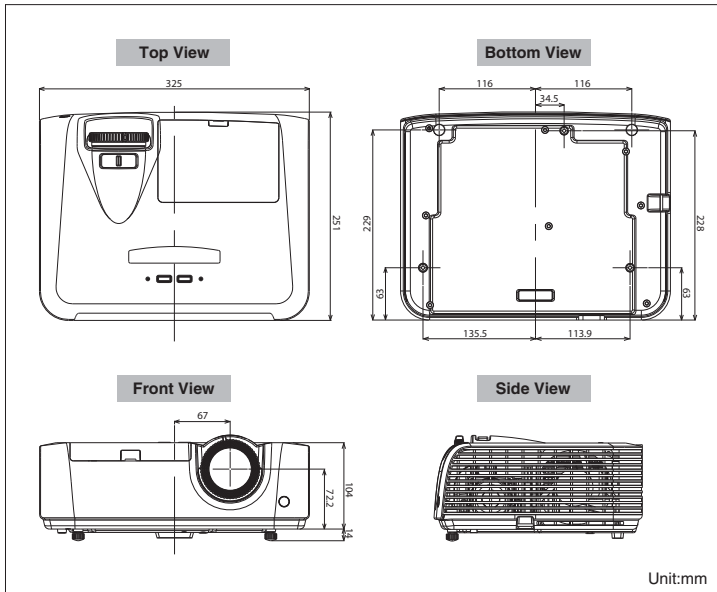

Specifications

Model	XD280U-G	XD250U-G
Display Technology	0.55" 1-Chip DMD	
Resolution	1024 x 768 (Total 786,432 pixels)	
Brightness	3000lm	2700lm
Contrast Ratio	2000 : 1	
Projection lens	f=18.4 ~22.0 mm, F=2.5-2.8, (130"-157"@100")	
Offset axis	7.9:1	
Picture Size	40" - 300"	
Throw Ratio	1.6 - 2.0	
Source Lamp	190W (Shut-off Time 6000hr) with Low Mode, 230W (Shut-off Time 3000hr) with Standard Mode	
PC Compatibility	640 x 480 - 1280 x 1024, True: 1024 x 768, Sync on Green available	
Video Compatibility	NTSC / NTSC 4.43 / PAL (including PAL-M, N) / SECAM / PAL-60 Component Video: 480i/p (525i/p), 576i/p (625i/p), 720p (750p), 1080i (1125i 60Hz), 1080i (1125i 50Hz)	
Input Terminals	RGB: mini D-sub 15pin x 2 Video: RCA x 1, S-VIDEO x 1 Digital: HDMI x 1 Audio: Stereo mini jack (ø3.5mm) x 2, RCA jack (L/R) x 1	
Output Terminals	RGB: mini D-sub 15pin x 1 Audio: Stereo mini jack (ø3.5mm) x 1 (variable)	
Communication Terminal	RS-232CL mini DIN 8pin x 1 LAN: RJ-45 x 1	
Audio Speaker	10W Mono	
Dimensions (W x H x D)	12.6" x 4.1" x 9.3" / 325 x 118 x 251 mm	
Weight	7.3lbs / 3.3kg	
Power Requirements	AC 100-240V, 50/60Hz	
Optional Lamp	VLT-XD280LP	
Optional Accessories	Ceiling mount (PROJ-UCM-PRO2), Hard shell case (DKT1-ATAC)	
Included Accessories	Soft carrying bag, Remote control (With 2 batteries), Power cable(1.8m), VGA(D-sub) cable(1.8m), User-Manual x1(CD-ROM), Safety manual, Lens Cap	
Warranty	3-Years of Parts/Labor, 3-Years of Express Replacement Assistance (ERA), 1-year or 500 hours lamp warranty (whichever comes first)	

*Compliance with ISO21118-2005
**All brand names and product names are trademarks, registered trademarks or trade names of their respective holders.

Screen size and Projection distance

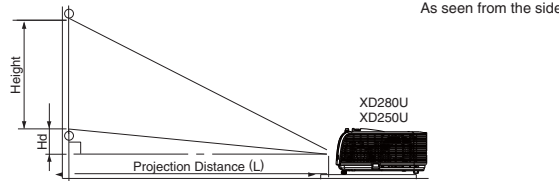

Screen size chart (4:3 aspect ratio)

Diagonal Size	Screen		Distance from screen (L)				Height projected image (Hd)				
	Width (W)	Height (H)	Max. Zoom	Min. Zoom							
inch	cm	inch	cm	inch	cm	inch	m	inch	m	inch	cm
40	102	32	81	24	61	51	1.3	62	1.6	3.6	9
60	152	48	122	36	91	77	2.0	94	2.4	5.4	14
80	203	64	163	48	122	103	2.6	125	3.2	7.2	18
100	254	80	203	60	152	129	3.3	157	4.0	9.0	23
150	381	120	305	90	229	195	4.9	236	6.0	13.4	34
200	508	160	406	120	305	260	6.6	315	8.0	17.9	45
250	635	200	508	150	381	326	8.3	394	10.0	22.4	57
300	762	240	610	180	457	391	9.9	-	-	26.9	68

The above numbers are approximate, and may be slightly different from the actual measurements.

Screen size chart (16:9 aspect ratio)

Diagonal Size	Screen		Distance from screen (L)				Height projected image (Hd)				
	Width (W)	Height (H)	Max. Zoom	Min. Zoom							
inch	cm	inch	cm	inch	cm	inch	m	inch	m	inch	cm
40	102	35	89	20	50	56	1.4	68	1.7	7.2	18
60	152	52	133	29	75	84	2.1	102	2.6	10.8	27
80	203	70	177	39	100	113	2.9	137	3.5	14.3	36
100	254	87	221	49	125	141	3.6	171	4.4	17.9	46
150	381	131	332	74	187	213	5.4	258	6.5	26.9	68
200	508	174	443	98	249	284	7.2	344	8.7	35.9	91
250	635	218	553	123	311	356	9.0	430	10.9	44.8	114
300	762	261	664	147	374	427	10.8	-	-	53.8	137

The above numbers are approximate, and may be slightly different from the actual measurements.

MITSUBISHI DIGITAL ELECTRONICS AMERICA, INC.
Presentation Products Division
Phone: 888.307.0349
www.mitsubishi-presentations.com

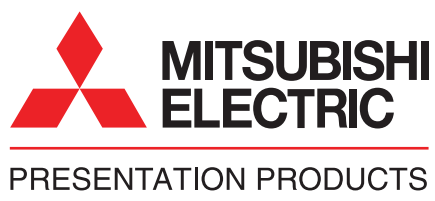

MITSUBISHI ELECTRIC SALES CANADA, INC.
Display & Imaging Solutions Division
Phone: 905.475.7728
www.mitsubishielectric.ca