

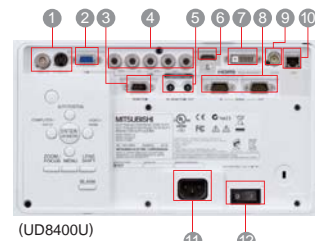

8000 SERIES

UD8400U/UD8400LU
WD8200U/WD8200LU
XD8100U/XD8100LU



(UD8400U)

Connection Terminals

- 1 S-Video/Video
- 2 PC/Component video input-1
- 3 Remote-1
- 4 PC/Component video input-2
- 5 Remote-2 (I/O)
- 6 HDMI
- 7 DVI-D
- 8 Serial RS-232C (I/O)
- 9 3G-SDI (UD8400U only)
- 10 LAN (RJ-45)
- 11 Power in (3-pin with earth terminal)
- 12 Main power switch O:Off I:On

Dimensions (unit: mm)

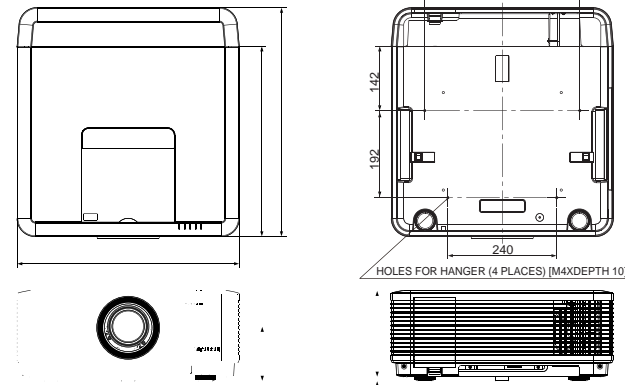

* The lens focal point is the default set at the time of shipment from the factory.

Specifications

Model	UD8400U / UD8400LU	WD8200U / WD8200LU	XD8100U / XD8100LU												
Display technology	0.67" 1-Chip DMD	0.65" 1-Chip DMD	0.7" 1-Chip DMD												
Resolution	1920 x 1200 (Total 2,304,000 pixels)	1280 x 800 (Total 1,024,000 pixels)	1024 x 768 (Total 786,432 pixels)												
Brightness	Dual lamp: 6500 lm Single lamp: 3250 lm	Dual lamp: 6500 lm Single lamp: 3250 lm	Dual lamp: 7000 lm Single lamp: 3500 lm												
Contrast ratio	2000 : 1 (on/off)														
Projection lens	f = 24.5-33.1mm, F = 2.0-2.4														
Zoom / focus	Powered focus / zoom (zoom ratio 1.35 : 1)														
Picture size	40" - 300"														
Throw ratio	4.65-2.27	1.74-2.39	1.73-2.36												
Source lamp	<table border="1"> <thead> <tr> <th>Lamp mode</th> <th>hour</th> </tr> </thead> <tbody> <tr> <td>Normal</td> <td>2,000 hours</td> </tr> <tr> <td>Low</td> <td>4,000 hours</td> </tr> </tbody> </table>		Lamp mode	hour	Normal	2,000 hours	Low	4,000 hours	<table border="1"> <thead> <tr> <th>Lamp mode</th> <th>hour</th> </tr> </thead> <tbody> <tr> <td>Normal</td> <td>4,000 hours</td> </tr> <tr> <td>Low</td> <td>8,000 hours</td> </tr> </tbody> </table>	Lamp mode	hour	Normal	4,000 hours	Low	8,000 hours
Lamp mode	hour														
Normal	2,000 hours														
Low	4,000 hours														
Lamp mode	hour														
Normal	4,000 hours														
Low	8,000 hours														
Computer compatibility	Resolution: 640 x 400 - 1920 x 1200 True: 1920 x 1200, Sync-on-Green available	Resolution: 640 x 400 - 1920 x 1200 True: 1280 x 800, Sync-on-Green available	Resolution: 640 x 400 - 1920 x 1200 True: 1024 x 768, Sync-on-Green available												
Video compatibility	NTSC / NTSC 4.43 / PAL (including PAL-M, N) / SECAM / PAL-60 Component video: 480i/p (525i/p), 576i/p (625i/p), 720p (750p 50/60Hz), 1080i (1125i 50/60Hz), 1080p (1125p 50/60Hz) SCART (RGB + 1V sync, only mini D-sub 15-pin Terminal)														
Input terminals	PC: 5 BNC x 1, mini D-sub 15-pin x 1, DVI-D (with HDCP) x 1 Video: BNC x 1, S-Video (4-pin) x 1, HDMI (Ver 1.3, Deep Color) x 1 3G-SDI x 1 (UD8400U only)														
Communication terminals	LAN (RJ-45): x 1 (projector control), SERIAL (in): D-sub 9-pin (male) x 1 (direct command is available.), SERIAL (out): D-sub 9-pin (male) x 1 (direct command is available.) Wired remote (in): x 1 (φ3.5mm stereo mini jack), Wired remote (out): x 1 (φ3.5mm stereo mini jack), Remote: D-sub 9-pin (female) x 1														
Dimensions (W×H×D)	19.3" x 7.9" x 16.6" (exclude detachable terminal cover and protrusion)														
Weight	35.3 lbs (exclude detachable terminal cover)														
Power supply	AC 100 - 240V, 50/60 Hz														
Included Accessories	AC Power Cable, RGB cable, RS-232C cable, Terminal-Cover, Remote Unit (incl. Battery), User Manual CD, Safety Manual, Labels for ceiling mount usage														
Warranty	3-Years or 10,000 hours (whichever comes first) Limited P&L Warranty, Express Replacement Assistance (ERA) during the warranty period, 1-yr or 500hrs lamp warranty (whichever comes first)														

*Varies depending on condition. *All brand names and product names are trademarks, registered trademarks or trade names of their respective holders. *Lamp life specification is an estimate based on verification under proper conditions and is not the duration of the warranty. Lamp will shut-off automatically when usage reaches the specified estimated maximum lamp hours. Service life may vary widely depending on usage and operating environment and conditions, as well as users' adherence to the maintenance and cleaning procedures provided in the user manual. *The above specifications are for the standard model only. Specifications are different for lens-less models. *HDMI, the HDMI Logo, and High-Definition Multimedia Interface are trademarks or registered trademarks of HDMI Licensing LLC in the United States and other countries.



for a greener tomorrow

Eco Changes is the Mitsubishi Electric Group's environmental statement, and expresses the Group's stance on environmental management. Through a wide range of businesses, we are helping contribute to the realization of a sustainable society.



UD8400U/UD8400LU
WD8200U/WD8200LU
XD8100U/XD8100LU



Brilliant Support for Various Presentation Venues

including business, education and entertainment



UD8400U / UD8400LU
WD8200U / WD8200LU
XD8100U / XD8100LU



Imagine a long presentation or seminar in a large, bright room like a hall or auditorium. The impact of that presentation will depend on the performance of the projector you use. To ensure reliable performance, these projectors are equipped with digital light processing (DLP™) technology that reproduces high-definition images in high contrast and with superior brightness.

Built for durability and easy installation and maintenance, they last and last with minimal upkeep. The 8000 Series are equipped with dual lamps, allowing the continuous projection of images for long periods of time together with greatly increased reliability.

For installation models, our aim was to ensure an advanced level of performance essential for such units.

High Brightness

Powerful Large-screen Images in Well-lit Halls/Auditoriums

7000lm High Brightness*

The XD8100U delivers a super bright 7000 lumen* brightness level for presenting in large meeting rooms and conference halls.

*Maximum brightness of WD8200U and UD8400U is 6500 lumens.

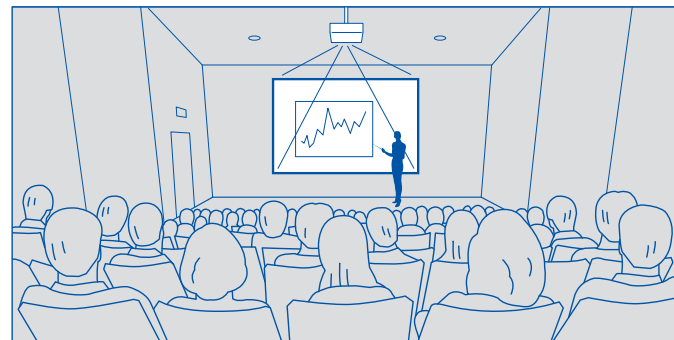

High Image Quality

Cutting-edge Technologies Reproduce Strikingly Sharp Images

Super Resolution

These projectors are equipped with Mitsubishi Electric's industry-leading, advanced image-processing algorithm, which is also used in our televisions and displays. The technology analyzes blurred components in the original images, estimates high-resolution data not provided in the original signal—and corrects the image quality. The result is the projection of sharp, vivid images in fine detail.

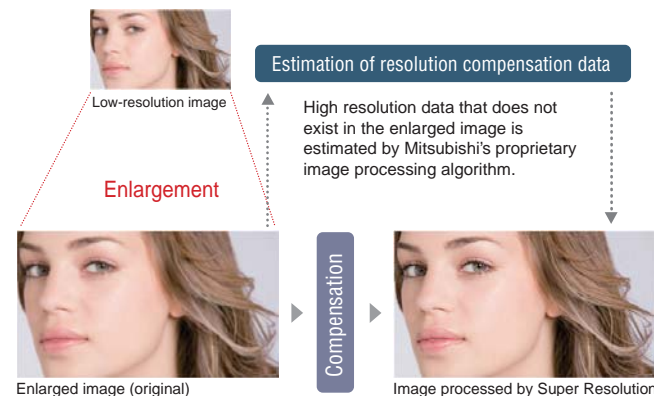

High Reliability

Durable and Reliable – Continuous 24/7 Use Capability

The dual lamp system and lamp relay function enables continuous operation with no risk of the image going out. Dust resistance and cooling performance are greatly enhanced by the automated self-cleaning filter and heat-pipe cooling system technologies that have proven so successful in air conditioners, enabling extended continuous use for monitoring and digital signage applications.

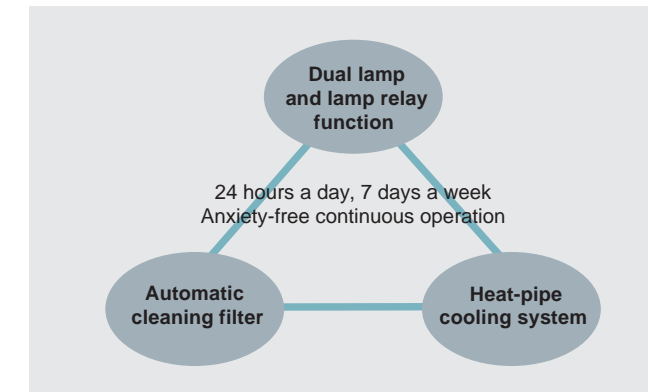

Various Lamp Relay Options

Continuous, bright projection is ensured through the utilization of a dual-lamp light source and a variety of setting options. When two lamps are in use, one of the lamps can be rested (turned off) once a day or week. Additionally, if only one lamp is being used and it goes out, an automatic back-up function activates the other lamp—enabling nonstop projection.

Resting on a weekly basis

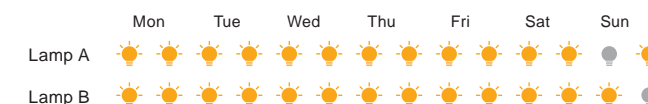

Resting on a daily basis

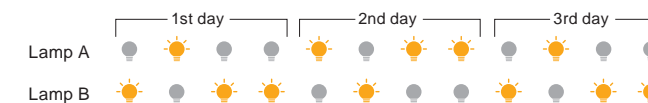

Automatic Cleaning Filter

For 8000 Series, we've utilized the same mechanism (mesh filter and cleaning brush) that has a proven track record in Mitsubishi Electric air conditioners and air purifiers is utilized.

It automatically prevents dust from building up in the radiator of the heat-pipe cooling unit for the digital micromirror device (DMD), thereby ensuring trouble-free use for extended periods of time.



Heat-pipe Cooling System

Compared to liquid-based cooling systems, this heat-pipe cooling system has a simplified structure and does not require a power supply, enabling a more compact design and reduced costs. Not only is it highly reliable, other benefits include exceptional energy savings, quiet operation and no concerns of liquid leakage.

Long 4000hrs Lamp Life

Designed with a lamp temperature controlling system, 8000 Series can support an estimated lamp rating of up to 4000 hours. The long estimated lamp life makes dramatic reductions in overall cost of ownership by decreasing the frequency of lamp replacements.

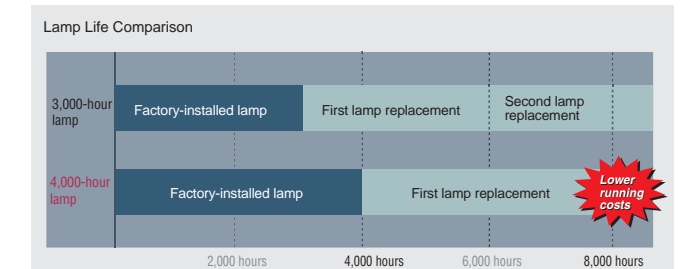

Lamp life specification is an estimate based on verification under proper conditions and is not the duration of the warranty. Lamp will shut-off automatically when usage reaches the specified estimated maximum lamp hours. Service life may vary widely depending on usage and operating environment and conditions, as well as users' adherence to the maintenance and cleaning procedures provided in the user manual.



For board room, conference hall



For Digital Signage

For Auditorium



Advanced Features for Increased Expressiveness and Operation Ease

Ultra Quiet 28dB Operation

Fan noise due to projector operation can be distracting during a presentation or videoconference. The 8000 Series projectors operate at a significantly low noise level of only 28dB (i.e., using a single lamp in “low lamp” mode). As a result—presentations and conferences can be held without distracting projector noise in the background.

Examples of Noise Levels

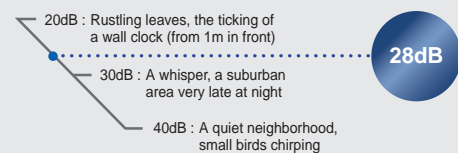

Geometric Corrections

Keystone Correction

Trapezoidal distortion caused when the projector is not positioned directly in front of the screen is corrected in both vertical and horizontal directions.

Cornerstone Correction

Pixel conversion is used to correct trapezoidal and diagonal distortion that causes oblique images, ensuring the proper aspect ratio.

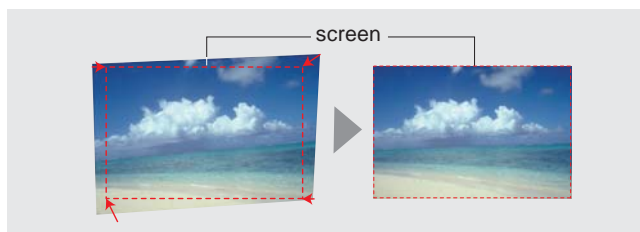

Curved-surface Projection Correction

Projectors in the 8000 series are equipped with a distortion correction function that can be used when projecting images onto curved surfaces. Coordinates at the image’s four corners are adjusted, enabling the projection angle to be adjusted at the time of angled or stacked projection. It is extremely handy for unique applications like projecting images onto special surfaces such as pillars at event sites.

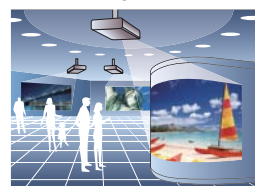

Multi-screen Solutions

Edge Blending

Edge blending creates a seamless image by adjusting the brightness at adjoining edges when using multiple projectors side-by-side to reproduce single widescreen images. This feature can also be utilized for top-bottom projection or a combination of side-by-side and top-bottom images; for example, when images are projected from four projectors in a two-by-two arrangement.

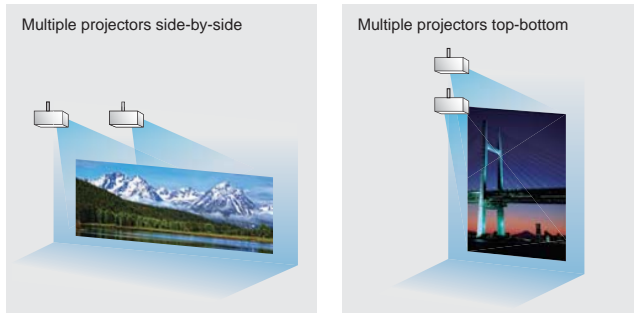
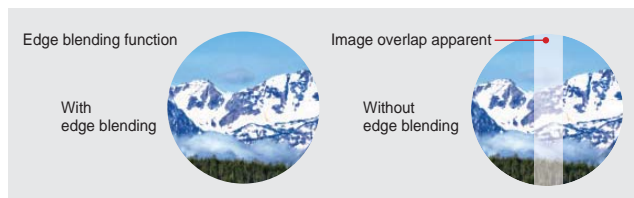

Color Matching

The use of multiple projectors to create a larger image can result in color variations due to slight differences in projector image processing. 8000 Series projectors are equipped with a color matching function that resolves this problem. Each projector is adjusted so that the same colors are reproduced when multiple projectors are used simultaneously.

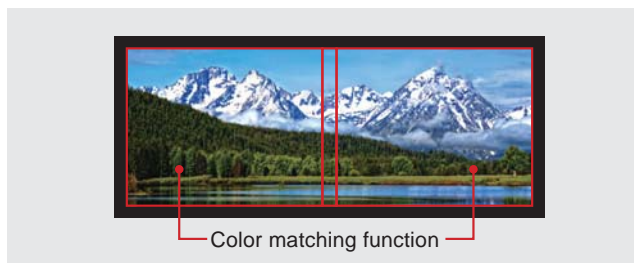

Interchangeable Color Wheels **Optional**

Projectors come equipped with a color wheel that accentuates brightness, and an optional color wheel for accentuating color is available. A sensor-based detection function is embedded in each unit to detect when a color wheel is replaced, at which time the color wheel index is automatically adjusted. This interchangeability enables a more appropriate expression of the images being reproduced.

360° Projection Capability

Images can be projected over a full 360° range along the vertical axis* including reproduction on the ceiling or floor. The application possibilities are limitless.



*Excluding use in high-altitude mode.

Network Connectivity

Projectors are equipped with a RJ-45 LAN terminal for remote operation. Additionally, when used with Crestron RoomView™, integrated control of up to 250 projectors including power on/off control, message display and confirmation of lamp service hours is possible. The 8000 Series are equipped with AMX Device Discovery for simplified device management and compatible with PJLink™.



The trademark of PJLink is trademark applied for registration or registered trademark in Japan, the United States, and other countries and areas.

Multiple Terminals

Many different interfaces are possible thanks to a variety of terminals including 3G-SDI (UD8400U only), DVI-D (HDCP), HDMI and 5BNC. A control terminal (compatible with RS-232C) is also provided for easier system integration.



(UD8400U)

ID-compatible Remote Control

ID settings for up to 63 projectors are possible. Setting the IDs allows control of each individual projector when multiple projectors are installed.

Power Zoom/Focus and Lens Shift

The zoom/focus and lens shift adjustment are powered by an electric motor, ensuring easy operation.

Stand-by Wattage under 0.3W*

Stand-by (low) mode power consumption is less than 0.3W, offering increased energy savings and further contributing to environmental preservation.

*When in stand-by (low) mode. At this time, use of the LAN function, serial output and Remote 1 is not possible.

Mechanical Shutter

An internal shutter in the projector enables light to be completely blocked when the projector is in Mute mode.

Lamp Side Access

The lamps can be accessed from the side of the unit.

- OSD menu multilanguage compatibility (19 languages*)
- 2-Screen mode (PinP: XD8100U Split: WD8200U, UD8400U)
- Direct power off
- Test pattern
- High-altitude mode (2,000 to 2,700 m)
- Closed caption support

*Previous languages: Chinese, English, French, German, Italian, Japanese, Korean, Polish, Portuguese, Russian, Spanish, Swedish
 Languages added: Dutch, Indonesian, Malaysian, Norwegian, Thai, Turkish, Vietnamese

UD8400/UD8400LU

Standard Lens (Aspect 16:10)

Image (WUXGA)		Distance from Screen		Default Height	Movable V Position from Default Position				Movable H Position from Default Position										
Diagonal Size	Width	Height	Shortest (Wide)	Longest (Tele)	Projected Image (HO)	H1	H2	H1	H2	W1	W1	W1	W1						
inch	cm	inch	cm	inch	cm	inch	cm	inch	cm	inch	cm	inch	cm						
40	102	34	86	21	54	55	1.4	76	1.9	0	0	10	-0 → 4	26	-0 → 10	3	-0 → 3	8	-0 → 8
60	152	51	129	32	81	83	2.1	115	2.9	0	0	15	-0 → 6	39	-0 → 15	5	-0 → 5	12	-0 → 12
80	203	68	172	42	106	112	2.8	154	3.9	0	0	21	-0 → 8	52	-0 → 20	7	-0 → 7	17	-0 → 17
100	254	85	215	53	135	141	3.6	193	4.9	0	0	26	-0 → 10	66	-0 → 25	8	-0 → 8	21	-0 → 21
150	381	127	323	79	202	213	5.4	291	7.4	0	0	39	-0 → 15	98	-0 → 37	12	-0 → 12	31	-0 → 31
200	508	170	431	106	269	285	7.2	389	9.9	0	0	52	-0 → 20	131	-0 → 50	16	-0 → 16	42	-0 → 42
250	635	212	538	132	337	356	9.1	-	-	0	0	65	-0 → 24	164	-0 → 62	20	-0 → 20	52	-0 → 52
300	762	254	646	159	404	428	10.9	-	-	0	0	77	-0 → 29	197	-0 → 75	25	-0 → 25	62	-0 → 62

OL-XD2000SZ (Aspect 16:10)

Image (WUXGA)		Distance from Screen		Default Height	Movable V Position from Default Position				Movable H Position from Default Position										
Diagonal Size	Width	Height	Shortest (Wide)	Longest (Tele)	Projected Image (HO)	H1	H2	H1	H2	W1	W1	W1	W1						
inch	cm	inch	cm	inch	cm	inch	cm	inch	cm	inch	cm	inch	cm						
40	102	34	86	21	54	42	1.1	59	1.5	0	0	10	-0 → 4	26	-0 → 10	3	-0 → 3	8	-0 → 8
60	152	51	129	32	81	65	1.6	90	2.3	0	0	15	-0 → 6	39	-0 → 15	5	-0 → 5	12	-0 → 12
80	203	68	172	42	106	87	2.2	121	3.1	0	0	21	-0 → 8	52	-0 → 20	7	-0 → 7	17	-0 → 17
100	254	85	215	53	135	104	2.8	152	3.9	0	0	26	-0 → 10	66	-0 → 25	8	-0 → 8	21	-0 → 21
150	381	127	323	79	202	167	4.2	229	5.8	0	0	39	-0 → 15	98	-0 → 37	12	-0 → 12	31	-0 → 31
200	508	170	431	106	269	224	5.7	307	7.8	0	0	52	-0 → 20	131	-0 → 50	16	-0 → 16	42	-0 → 42
250	635	212	538	132	337	281	7.1	-	-	0	0	65	-0 → 24	164	-0 → 62	20	-0 → 20	52	-0 → 52
300	762	254	646	159	404	338	8.6	-	-	0	0	77	-0 → 29	197	-0 → 75	25	-0 → 25	62	-0 → 62

OL-XD2000LZ (Aspect 16:10)

Image (WUXGA)		Distance from Screen		Default Height	Movable V Position from Default Position				Movable H Position from Default Position										
Diagonal Size	Width	Height	Shortest (Wide)	Longest (Tele)	Projected Image (HO)	H1	H2	H1	H2	W1	W1	W1	W1						
inch	cm	inch	cm	inch	cm	inch	cm	inch	cm	inch	cm	inch	cm						
40	102	34	86	21	54	-	-	89	2.3	0	0	10	-0 → 4	26	-0 → 10	3	-0 → 3	8	-0 → 8
60	152	51	129	32	81	107	2.7	137	3.5	0	0	15	-0 → 6	39	-0 → 15	5	-0 → 5	12	-0 → 12
80	203	68	172	42	106	146	3.7	185	4.7	0	0	21	-0 → 8	52	-0 → 20	7	-0 → 7	17	-0 → 17
100	254	85	215	53	135	184	4.7	233	5.9	0	0	26	-0 → 10	66	-0 → 25	8	-0 → 8	21	-0 → 21
150	381	127	323	79	202	279	7.1	353	9.0	0	0	39	-0 → 15	98	-0 → 37	12	-0 → 12	31	-0 → 31
200	508	170	431	106	269	374	9.5	473	12.0	0	0	52	-0 → 20	131	-0 → 50	16	-0 → 16	42	-0 → 42
250	635	212	538	132	337	470	11.9	592	15.0	0	0	65	-0 → 24	164	-0 → 62	20	-0 → 20	52	-0 → 52
300	762	254	646	159	404	565	14.4	712	18.0	0	0	77	-0 → 29	197	-0 → 75	25	-0 → 25	62	-0 → 62

OL-XD2000TZ (Aspect 16:10)

Image (WUXGA)		Distance from Screen		Default Height	Movable V Position from Default Position				Movable H Position from Default Position										
Diagonal Size	Width	Height	Shortest (Wide)	Longest (Tele)	Projected Image (HO)	H1	H2	H1	H2	W1	W1	W1	W1						
inch	cm	inch	cm	inch	cm	inch	cm	inch	cm	inch	cm	inch	cm						
40	102	34	86	21	54	-	-	151	3.8	0	0	10	-0 → 4	26	-0 → 10	3	-0 → 3	8	-0 → 8
60	152	51	129	32	81	139	3.5	229	5.8	0	0	15	-0 → 6	39	-0 → 15	5	-0 → 5	12	-0 → 12
80	203	68	172	42	106	187	4.8	308	7.8	0	0	21	-0 → 8	52	-0 → 20	7	-0 → 7	17	-0 → 17
100	254	85	215	53	135	235	6.0	386	9.8	0	0	26	-0 → 10	66	-0 → 25	8	-0 → 8	21	-0 → 21
150	381	127	323	79	202	355	9.0	581	14.8	0	0	39	-0 → 15	98	-0 → 37	12	-0 → 12	31	-0 → 31
200	508	170	431	106	269	475	12.1	776	19.7	0	0	52	-0 → 20	131	-0 → 50	16	-0 → 16	42	-0 → 42
250	635	212	538	132	337	595	15.1	972	24.7	0	0	65	-0 → 24	164	-0 → 62	20	-0 → 20	52	-0 → 52
300	762	254	646	159	404	716	18.2	1167	29.6	0	0	77	-0 → 29	197	-0 → 75	25	-0 → 25	62	-0 → 62

OL-XD8000UZ (Aspect 16:10)

Image (WUXGA)		Distance from Screen		Default Height	Movable V Position from Default Position				Movable H Position from Default Position										
Diagonal Size	Width	Height	Shortest (Wide)	Longest (Tele)	Projected Image (HO)	H1	H2	H1	H2	W1	W1	W1	W1						
inch	cm	inch	cm	inch	cm	inch	cm	inch	cm	inch	cm	inch	cm						
60	152	51	129	32	81	234	5.9	447	11.4	0	0	15	-0 → 6	39	-0 → 15	5	-0 → 5	12	-0 → 12
80	203	68	172	42	106	309	7.8	594	15.0	0	0	21	-0 → 8	52	-0 → 20	7	-0 → 7	17	-0 → 17
100	254	85	215	53	135	384	9.8	740	18.8	0	0	26	-0 → 10	66	-0 → 25	8	-0 → 8	21	-0 → 21
150	381	127	323	79	202	573	14.5	1107	28.1	0	0	39	-0 → 15	98	-0 → 37	12	-0 → 12	31	-0 → 31
200	508	170	431	106	269	761	19.3	1473	37.4	0	0	52	-0 → 20	131	-0 → 50	16	-0 → 16	42	-0 → 42
250	635	212	538	132	337	950	24.1	-	-	0	0	65	-0 → 24	164	-0 → 62	20	-0 → 20	52	-0 → 52
300	762	254	646	159	404	1138	28.9	-	-	0	0	77	-0 → 29	197	-0 → 75	25	-0 → 25	62	-0 → 62

OL-XD2000FR (Aspect 16:10)

Image (WXGA)		Distance from Screen		Default Height	Movable V Position from Default Position				Movable H Position from Default Position				
Diagonal Size	Width	Height	Shortest (Wide)	Longest (Tele)	Projected Image (HO)	H1	H2	H1	H2	W1	W1	W1	W1
inch	cm	inch	cm	inch	cm	inch	cm	inch	cm	inch	cm	inch	cm
40	102	34	86	21	54	25	0.6	-11	-27	-	-	-	-
60	152	51	129	32	81	39	1.0	-16	-40	-	-	-	-
80	203	68	172	42	106	52	1.3	-21	-54	-	-	-	-
100	254	85	215	53	135	66	1.7	-26	-67	-	-	-	-
150	381	127	323	79	202	99	2.5	-40	-101	-	-	-	-

Screen Size and Projection Distance

Refer to the following table to determine the screen size and projection distance.

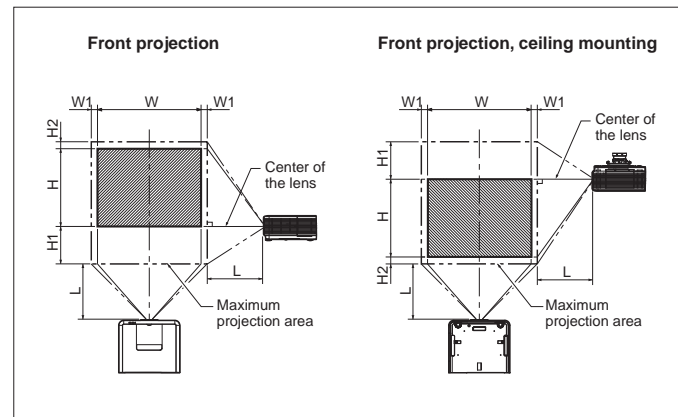

Standard Lens (Aspect 16:9)

Image (1080p)		Distance from Screen		Default Height	Movable V Position from Default Position				Movable H Position from Default Position										
Diagonal Size	Width	Height	Shortest (Wide)	Longest (Tele)	Projected Image (HO)	H1	H2	H1	H2	W1	W1	W1	W1						
inch	cm	inch	cm	inch	cm	inch	cm	inch	cm	inch	cm	inch	cm						
40	102	35	89	20	50	56	1.4	78	2.0	1	3	11	-0 → 4	27	-0 → 10	3	-0 → 3	9	-0 → 9
60	152	52	133	29	75	86	2.2	118	3.0	2	4	16	-0 → 6	40	-0 → 15	5	-0 → 5	13	-0 → 13
80	203	70	177	39	100	115	2.9	158	4.0	2	6	21	-0 → 8	54	-0 → 20	7	-0 → 7	17	-0 → 17
100	254	87	221	49	125	145	3.7	198	5.0	3	7	27	-0 → 10	67	-0 → 26	8	-0 → 8	21	-0 → 21
150	381	131	332	74	187	219	5.6	299	7.6	4	11	40	-0 → 15	101	-0 → 38	13	-0 → 13	32	-0 → 32
200	508	174	443	98	249	293	7.4	399	10.1	6	14	53	-0 → 20	135	-0 → 51	17	-0 → 17	43	-0 → 43
250	635	218	553	123	311	366	9.3	-	-	7	18	66	-0 → 25	168	-0 → 64	21	-0 → 21	53	-0 → 53

OL-XD2000SZ (Aspect 16:9)

Image (1080p)		Distance from Screen		Default Height	Movable V Position from Default Position				Movable H Position from Default Position										
Diagonal Size	Width	Height	Shortest (Wide)	Longest (Tele)	Projected Image (HO)	H1	H2	H1	H2	W1	W1	W1	W1						
inch	cm	inch	cm	inch	cm	inch	cm	inch	cm	inch	cm	inch	cm						
40	102	35	89	20	50	43	1.1	60	1.5	1	3	11	-0 → 4	27	-0 → 10	3	-0 → 3	9	-0 → 9
60	152	52	133	29	75	67	1.7	92	2.3	2	4	16	-0 → 6	40	-0 → 15	5	-0 → 5	13	-0 → 13
80	203	70	177	39	100	90	2.3	124	3.2	2	6	21	-0 → 8	54	-0 → 20	7	-0 → 7	17	-0 → 17
100	254	87	221	49	125	113	2.9	156	4.0	3	7	27	-0 → 10	67	-0 → 26	8	-0 → 8	21	-0 → 21
150	381	131	332	74	187	172	4.4	236	6.0	4	11	40	-0 → 15	101	-0 → 38	13	-0 → 13	32	-0 → 32
200	508	174	443	98	249	230	5.9	316	8.0	6	14	53	-0 → 20	135	-0 → 51	17	-0 → 17	43	-0 → 43