

**FUJIFILM**

Projector

**FP-Z5000**

**Basic Manual**

(Installation and Basic Operation)

FUJIFILM



PROJECTOR

**FUJIFILM Corporation**

BL00005017-202

---

# Table of Contents

---

<b>Safety Precautions</b>	<b>1</b>
<b>For Your Safety</b> .....	<b>1</b>
⚠ WARNINGS.....	1
⚠ CAUTIONS.....	2
Precautions for Storage and Use.....	3
<b>Safe Use of Lasers</b> .....	<b>4</b>
⚠ WARNINGS.....	4
⚠ CAUTION.....	4
Notes on the Laser.....	4
Laser Warning Stickers.....	4
<b>NOTICES</b>	<b>5</b>
Caution:.....	5
FCC Warning:.....	5
For Customers In Canada.....	5
About the Icons.....	6
Disposal of Electrical and Electronic Equipment in Private Households In the European Union, Norway, Iceland and Liechtenstein:.....	6
<b>Introduction</b>	<b>7</b>
<b>Package Contents</b> .....	<b>7</b>
<b>Parts of the Projector</b> .....	<b>8</b>
<b>Installation</b>	<b>9</b>
<b>Choosing a Location</b> .....	<b>9</b>
Spacing.....	9
Installing the Projector in Vertical Orientation.....	10
Using the Stands.....	10
Lens Shift Range and Projection Distance.....	11
<b>Basic Operation</b>	<b>15</b>
<b>The Control Panel</b> .....	<b>15</b>
<b>On/Standby</b> .....	<b>16</b>
Turning the Projector On.....	16
Switching to Standby.....	16

<b>Projector Settings</b>	<b>17</b>
Rotating the Lens .....	17
Focus.....	19
Lens Shift.....	20
Zoom.....	21
Keystone Compensation .....	22
<b>Connections</b>	<b>23</b>
Connecting HDMI Devices.....	23
Connecting Third-Party Video Transmitters .....	23
<b>Technical Notes</b>	<b>24</b>
Supported Resolutions .....	24
HDMI/HDBaseT .....	24
The Remote Control .....	25
Indicator Lamps.....	26
<b>Regulatory</b>	<b>27</b>
Safety.....	27
Laser Safety.....	27
Electro-Magnetic Compatibility .....	27
Emissions .....	27
Immunity .....	27
Environmental.....	27
Marking .....	27
<b>Federal Communications Commission (FCC) warning</b>	<b>28</b>

### Owner's Manual

See the Owner's Manual for more information.

<https://optics.fujifilm.com/projector/en/spec/manual/fp-z5000/>

---

# Safety Precautions

---

## For Your Safety

The ⚠ **WARNING** and ⚠ **CAUTION** indications in this document indicate the following:

⚠ **WARNINGS** Failure to observe warnings could result in death or serious injury.

⚠ **CAUTIONS** Failure to observe cautions could result in injury or property damage.

This section lists important precautions that must be followed to ensure safe and correct use of the product. Read them before using the product and observe them during use.

### **⚠ WARNINGS**

- Be sure the product is installed securely. Serious accidents could result should the product fall from a height.
- Ceiling installations (where the product is suspended from the ceiling) should be performed only by professionals with the requisite skills. If installed incorrectly, the product could fall, potentially causing a serious accident.
- When working in high places, work with a partner, use a safety line, and take all other precautions necessary to ensure safety. Slipping, falling, or loss of balance could result in serious accidents.
- When installing the product in high places, ensure that people below keep their distance. Falling objects could cause serious accidents.
- Do not install or use the product in a bath or shower. Failure to observe this precaution could result in fire or electric shock.
- Do not handle the product with wet hands. Failure to observe this precaution could result in electric shock.
- Do not modify, tug, or twist the connecting cables, subject them to excessive heat, or place them under heavy objects. Damage to the cables could result in fire or electric shock. Should the cables be damaged, contact a Fujifilm-authorized service technician.
- Do not use cables if their connectors have ever been bent.
- Do not place the product on unstable surfaces. Be sure the product is level. Injury could result if the product tips or falls.
- Do not touch the metal parts of the product during thunderstorms. Lightning strikes can produce induced current that could cause electric shock.
- Do not place vessels containing water, chemicals, or other liquids on the product. Liquid that finds its way into the product could cause fire or electric shock.
- Never look directly into the lens while the product is on. The bright light could cause visual impairment or other injury. Do not look into the lens with magnifying glasses, telescopes, or other optical instruments.
- Do not insert flammable material, metal, or other foreign objects into the product or leave them in its vicinity. Failure to observe this precaution could result in fire, burns, or electric shock.
- Do not use sprays containing flammable gas to remove dust or other foreign matter from the lens. The gas could ignite, causing fire.
- Do not use the product in locations where the air may contain flammable or explosive gases. The gases could ignite, causing fire.
- Do not place flammable objects in front of the lens. Failure to observe this precaution could result in fire.

- Do not block the light from the product with books, cloths, or other objects. Objects placed in the beam could become hot, potentially melting or causing burns or fire. Light reflected from the objects could also cause the lens to overheat, causing product malfunction.
- Do not touch the lens or metal parts of the product while it is on or immediately after it has been switched to standby. Failure to observe this precaution could result in burns or other injury.
- Be careful not to drop the product when lifting it.
- Should you notice that the product is not functioning normally, switch it to standby and disconnect the power and USB cables. Continuing to use the product when it is emitting smoke or unusual smells or otherwise functioning abnormally could result in fire, electric shock, or visual impairment.

### **CAUTIONS**

- Use the product only as described in this manual.
- The product and its accessories are precision devices. Under no circumstances should they be subjected to excessive force.
- Be careful not to drop the product when lifting it to attach the stands.
- Attach the stands securely. When using the stands, be sure the legs are fully open. If the stands are not securely attached or the legs are not fully open when the product is oriented vertically, the product could become unbalanced and tip.
- Replace the lens cap if the product will not be used for an extended period.
- The lens includes moving parts: do not apply excessive force or subject the lens to physical shocks.
- Do not leave the product in locations where it will be exposed to soot, steam, or excessive humidity or dust. Failure to observe this precaution could result in fire or electric shock.
- Do not leave the product in locations where it will be exposed to high temperatures or direct sunlight. Failure to observe this precaution could result in fire.
- Do not leave the product or, if the batteries are inserted, the remote control unattended in locations exposed to direct sunlight or high temperatures, for example directly in the path of warm air from a heater. Excessive heat could deform the casing or damage the product's internal parts, resulting in fire.
- Do not place heavy objects on the product. The objects could become unbalanced and tip or fall, causing injury.
- Do not use the power cable if the plug is damaged or does not fit securely into the socket. Failure to observe this precaution could result in fire or electric shock.
- Keep your face and hands, as well as objects that may be warped or otherwise damaged by heat, away from the exhaust vent while the product is in use. The hot air from the vent could cause burns or deform or damage the objects.
- For safety, be sure to unplug the product when it is not in use. Failure to observe this precaution could result in fire due to deterioration of the insulation or other causes.
- Before transporting or cleaning the product, switch it to standby, unplug it from the power outlet, and disconnect all cables. Failure to observe this precaution could result in fire or electric shock.
- When cleaning the product, do not use damp cloths or solvents such as alcohol, benzine (petroleum ether), or thinner. Water could enter the product or the casing could weaken and break or suffer other damage, potentially resulting in electric shock.
- The accumulation of dust inside the product could result in fire or malfunction. We recommend that the interior of the product be periodically inspected and cleaned. Contact the original retailer for these services.
- Do not lift the product by the lens. Failure to observe this precaution could damage the product.

## Safety Precautions

- When using the product at high altitudes (above 1,500 m/4,900 ft), enable high-altitude mode to ensure that the product's internal temperature-control mechanism functions correctly. Failure to observe this precaution could shorten the life of the product's parts.
- Be sure to use the dedicated stands when the product is oriented vertically.
- Should you notice that the product is not functioning normally, switch it to standby and disconnect the power and USB cables. Continuing to use the product when it is emitting smoke or unusual smells or otherwise functioning abnormally could result in fire, electric shock, or visual impairment. Consult the original retailer.
- Do not drop water or foreign objects into the product. Should water or other foreign matter find its way into the interior, switch the product to standby and unplug it from the power outlet. Continued use could result in a short circuit causing fire or electric shock. Consult the original retailer.
- Do not disassemble or modify the product (never open the case). Failure to observe this precaution could result in fire or electric shock.
- Keep small parts out of the hands of young children. Because of their size, small objects such as batteries from the remote control may be accidentally swallowed by young children. Keep small parts out of their reach. Should a child swallow any part of the product, consult a physician immediately.
- Keep safety in mind when stringing cables. Failure to observe this precaution could result in falls or injury.
- Do not install the product in locations subject to shock or vibration.
- Do not touch the lens immediately after switching the product to standby. Failure to observe this precaution could result in burns.
- Be sure the product is properly grounded. The product is equipped with a grounded two-prong plug. Be sure the outlet is grounded.

### **Precautions for Storage and Use**

- Do not use or store the product in locations subject to extreme temperatures. Avoid locations that are subject to sudden changes in temperature. Operate and store the product within its operating and storage temperature limits.
- Do not install the product in the vicinity of high-voltage power lines or equipment that produces magnetic fields. The product may not function as expected.
- Do not use the product when it is tilted. Failure to observe this precaution could damage the product or cause accidents.
- Do not touch the lens with your bare hands. Fingerprints and smudges on the lens can affect picture quality. To keep the lens clean and free of scratches, replace the lens cap when the product is not in use.
- Remove the batteries from the remote control before placing it in storage. Leaving the batteries in place for long periods could result in leakage or other damage to the batteries.
- Do not use or store the product where it will be exposed to soot or tobacco smoke. Failure to observe this precaution could result in reduced picture quality.
- To clean the lens, first switch the product to standby and wait for the lens and metal parts to cool, then remove dust and lint with a blower before gently wiping the lens with a third-party glass-cleaning cloth or the like.
- Allow the lens to cool before performing cleaning or maintenance.

## Safe Use of Lasers

This equipment is defined as a Class 1 laser product under JIS C 6802:2014. Be sure to observe the following warnings and caution.

### **⚠ WARNINGS**

- This product contains a laser; do not open the case.
- Bright light can cause visual impairment or other injury; do not look directly at the light source.
- Never attempt to remodel or disassemble the projector. High voltages can cause fire or electric shocks.

### **⚠ CAUTION**

Dispose of this product in accord with location regulations; do not disassemble.

### **Notes on the Laser**

This product uses a laser as a light source, which has the following characteristics:

- The light source may dim under certain conditions.
- The higher the temperature, the more the source will dim.
- The source will grow dimmer the longer it is used.
- The relation between source brightness and length of use can be adjusted using brightness settings.
- For any inspection, adjustment and repair work, please contact an Authorized Service Center. Doing so may cause exposure to dangerous laser radiation.
- The laser module is built in this projector. Follow procedures specified in the Operating Instructions to make operations and adjustments.

### **Laser Warning Stickers**

Laser warning stickers are affixed to the side and interior of the product.

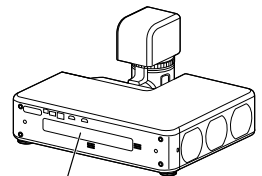
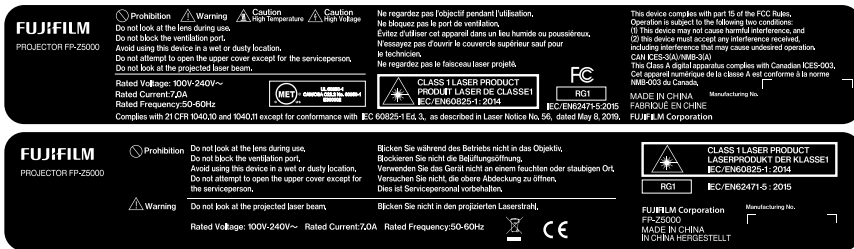

Laser warning stickers

### **Specifications of laser source**

- Wavelength: 455 nm
- Maximum Output: 95W

---

# NOTICES

---

## Verification

Model Number: FP-Z5000

Trade Mark: Fujifilm

This device complies with Part 15 of the FCC Rules.

Operation is subject to the following two conditions:

(1) This device may not cause harmful interference, and (2) this device must accept any interference received, including interference that may cause undesired operation.

## **Caution:**

This equipment has been tested and found to comply with the limits for a Class A digital device, pursuant to part 15 of the FCC Rules.

These limits are designed to provide reasonable protection against harmful interference when the equipment is operated in a commercial environment.

This equipment generates, uses, and can radiate radio frequency energy and, if not installed and used in accordance with the instruction manual, may cause harmful interference to radio communications. Operation of this equipment in a residential area is likely to cause harmful interference in which case the user will be required to correct the interference at his own expense.

## **FCC Warning:**

To assure continued compliance, follow the attached installation instructions. This includes using the provided power cord and shielded interface cables when connecting to computer or peripheral devices. Also, any unauthorized changes or modifications to this equipment could void the user's authority to operate this device.

## **For Customers In Canada**

CAN ICES-3(A)/NMB-3(A)

**WARNING:** This equipment is compliant with Class A of CISPR32. In a residential environment this equipment may cause radio interference.

This product complies with the following EU Directives:

- RoHS Directive 2011/65/EU
- EMC Directive 2014/30/EU
- LVD Directive 2014/35/EU

Compliance with these directives implies conformity to applicable harmonized European standards (European Norms) which are listed on the EU Declaration of Conformity issued by FUJIFILM Corporation for this product or product family.

This compliance is indicated by the following conformity marking placed on the product:





This marking is valid for non-Telecom products and EU harmonized Telecom products (e.g. Bluetooth).



## About the Icons

The symbols on the product represent the following:

	AC
	DC
	Class II equipment (The construction of the product is double-insulated.)

## Disposal of Electrical and Electronic Equipment in Private Households In the European Union, Norway, Iceland and Liechtenstein:

This symbol on the product, or in the manual and in the warranty, and/or on its packaging indicates that this product shall not be treated as household waste. Instead it should be taken to an applicable collection point for the recycling of electrical and electronic equipment. By ensuring this product is disposed of correctly, you will help prevent potential negative consequences to the environment and human health, which could otherwise be caused by inappropriate waste handling of this product.



# Introduction

## Package Contents

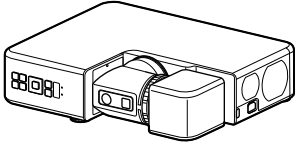

*Projector*

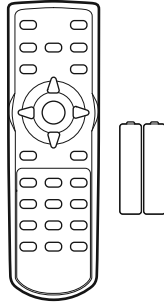

*Remote control with  
two AAA batteries*

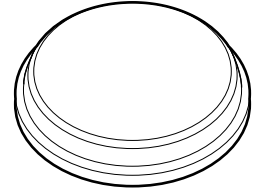

*Lens cap*

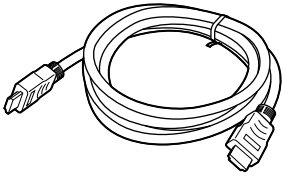

*HDMI cable (approximately  
1.8 m/5.9 ft)*

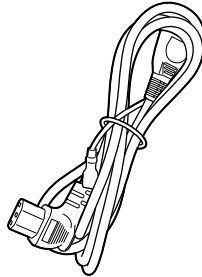

*Power cable (approximately  
3 m/9.8 ft)*

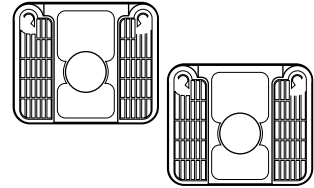

*Stand (x2)*

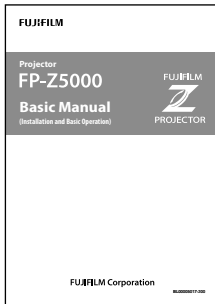

*Basic Manual (this manual)*

## Parts of the Projector

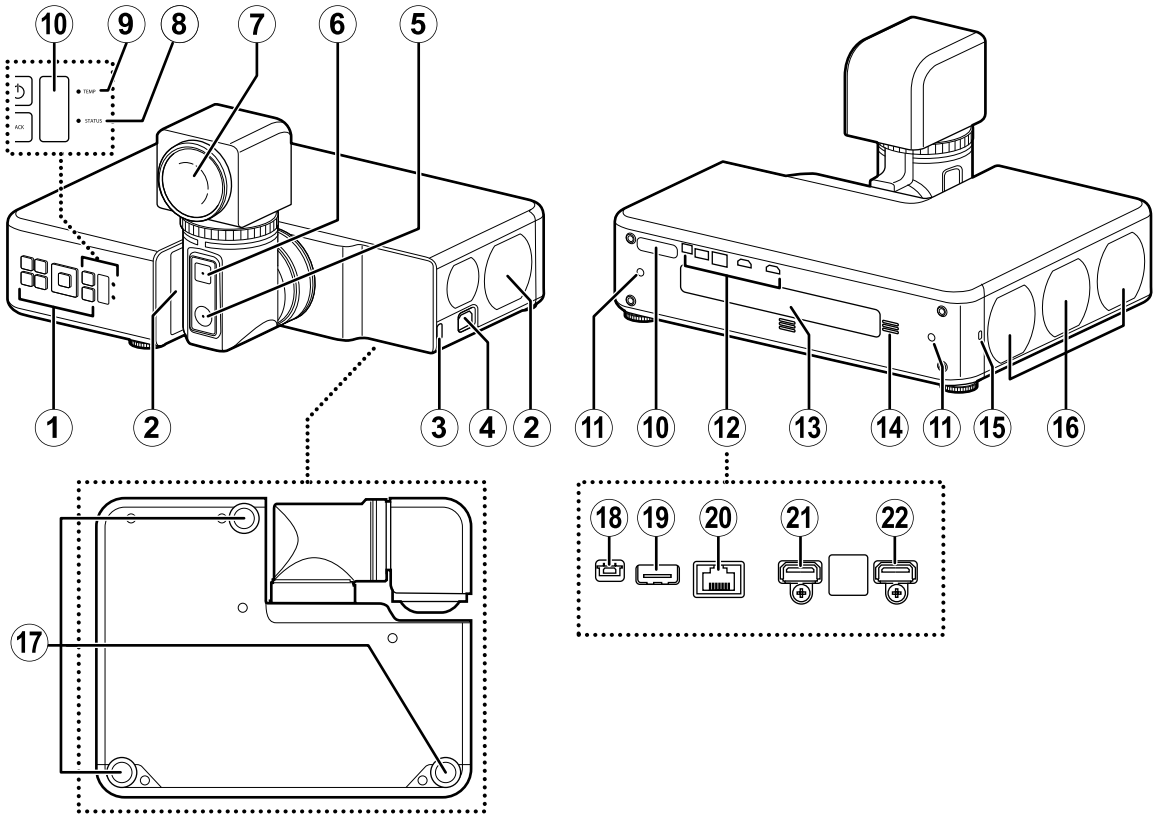

Item	Name	See page	Item	Name	See page
①	Control panel	15	⑫	Interface (connector) panel	23
②	Intake vents	9	⑬	Model number plate (laser warning sticker)	4
③	HDMI 3 connector	23	⑭	Speaker	—
④	Power connector	16	⑮	Security slot *	—
⑤	Arm latch release	17	⑯	Exhaust vents	9
⑥	Head latch release		⑰	Adjustable feet	—
⑦	Lens	26	⑱	Service connector	
⑧	Status lamp		⑲	USB connector (5 V DC power supply)	
⑨	Temperature warning lamp	10	⑳	HDBaseT/LAN connector	23
⑩	Remote receivers		㉑	HDMI 1 connector	
⑪	Screw holes for attaching stands	㉒	HDMI 2 connector		

\* Compatible with Kensington MicroSaver security system locks.

# Installation

## Choosing a Location

### Spacing

When installing the projector, choose a location where the vents will be a safe distance from walls or other obstructions.

- Intake: 40 cm (1.3 ft)
- Exhaust: 40 cm (1.3 ft)

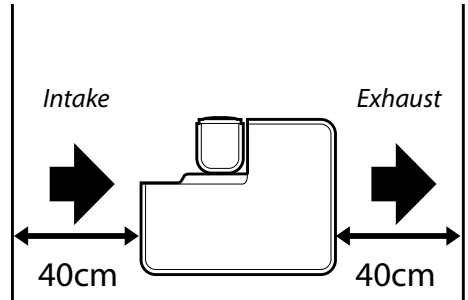

When installing two or more projectors side-by-side, leave a space of at least 80 cm (2.6 ft) between them. You will also need to ensure that the warm air from the exhaust vents does not enter any of the projectors' intake vents.

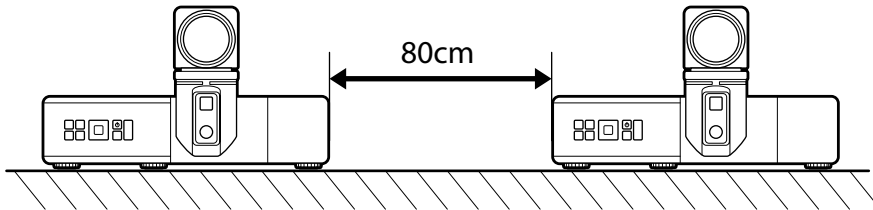

**CAUTION** Do not obstruct the vents. The build-up of heat inside the projector could cause fire.

### **Installing the Projector in Vertical Orientation**

Before installing the projector in vertical orientation, attach the supplied stands.



**TIP** The supplied stand does not incorporate a height-adjustment mechanism.

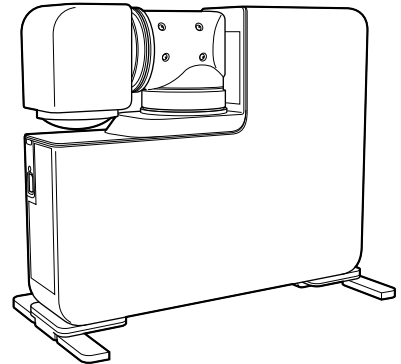

### **Using the Stands**

Before installing the projector in vertical orientation, attach the supplied stands. Attach the stands using their built-in screws, which screw into the attachment holes on the projector. When attaching the stands, lay the projector flat. The lens should be in the storage position, the projector in standby mode, and the power cable disconnected.

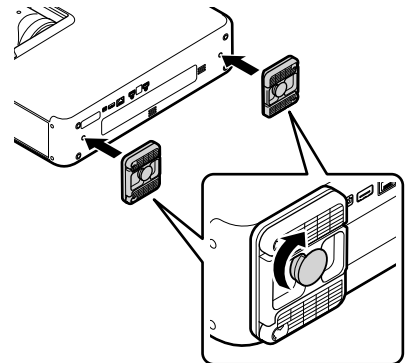

Open the legs after standing the projector on edge.

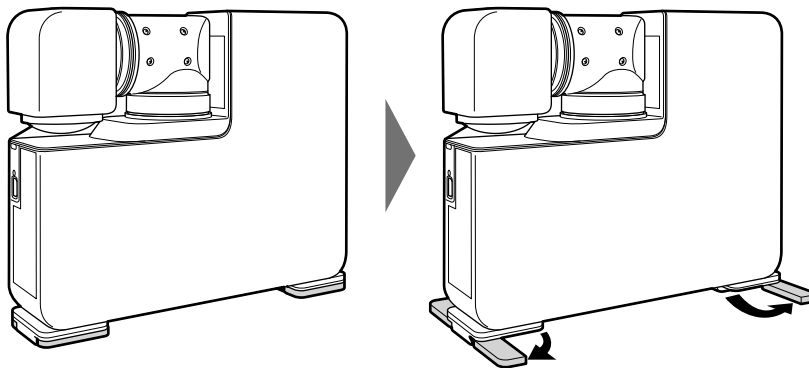

### **CAUTIONS**

- Be careful not to drop the projector when lifting it to attach the stands.
- Attach the stands securely. When using the stands, be sure the legs are fully open. If the stands are not securely attached or the legs are not fully open when the projector is oriented vertically, the projector could become unbalanced and tip.

## **Lens Shift Range and Projection Distance**

### ***Lens Shift Range: Landscape Orientation***

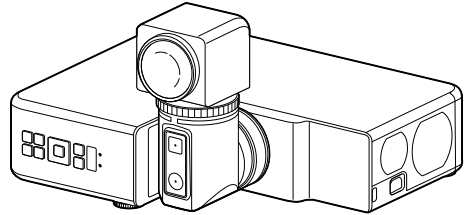
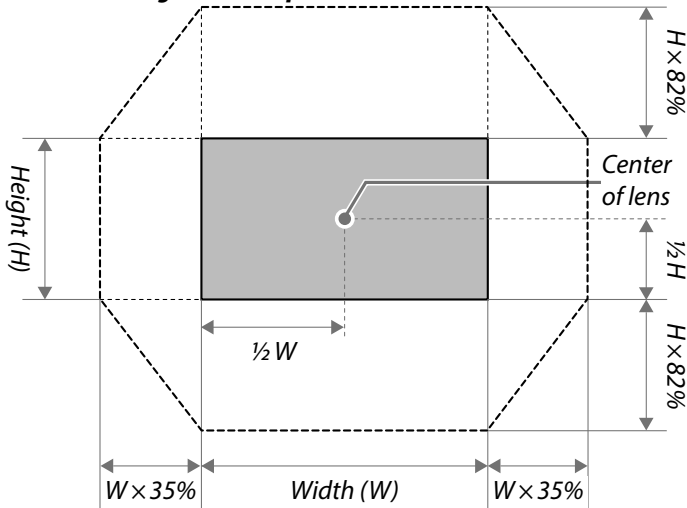

### ***Projection Distance***

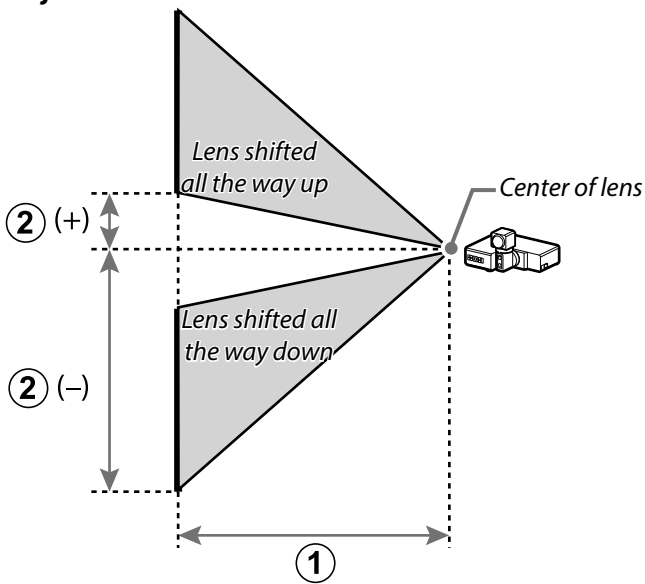

More details on projection distance are available via a simulator on the Fujifilm website:

<https://optics.fujifilm.com/projector/en/spec/>

- ① Projection distance (cm/in), minimum (projector zoomed all the way out) to maximum (projector zoomed all the way in)
- ② Vertical distance from center of lens to bottom of screen (cm/in)

**Projection Distances (Landscape Orientation)**

Screen dimensions (16:9)		① Projection distance (cm/in) min. zoom–max. zoom	② Vertical shift (cm/in) lowest to highest
Diagonal (in)	W × H (cm/in)		
70	155 × 87 / 61.0 × 34.3	52– 57 / 20.5–22.4	–115 to +28 / –45.3 to +11.0
80	177 × 100 / 69.7 × 39.4	59– 65 / 23.2–25.6	–131 to +32 / –51.6 to +12.6
90	199 × 112 / 78.3 × 44.1	67– 74 / 26.4–29.1	–148 to +36 / –58.3 to +14.2
100	221 × 125 / 87.0 × 49.2	75– 82 / 29.5–32.3	–164 to +40 / –64.6 to +15.7
120	266 × 149 / 104.7 × 58.7	90– 99 / 35.4–39.0	–197 to +48 / –77.6 to +18.9
150	332 × 187 / 130.7 × 73.6	113–124 / 44.5–48.8	–247 to +60 / –97.2 to +23.6
200	443 × 249 / 174.4 × 98.0	151–166 / 59.4–65.4	–329 to +80 / –129.5 to +31.5
250	553 × 311 / 217.7 × 122.4	189–208 / 74.4–81.9	–411 to +100 / –161.8 to +39.4
300	664 × 374 / 261.4 × 147.2	227–250 / 89.4–98.4	–493 to +120 / –194.1 to +47.2

Screen dimensions (16:10)		① Projection distance (cm/in) min. zoom–max. zoom	② Vertical shift (cm/in) lowest to highest
Diagonal (in)	W × H (cm/in)		
70	151 × 85 / 59.4 × 33.5	56– 62 / 22.0– 24.4	–112 to +27 / –44.1 to +10.6
80	172 × 97 / 67.7 × 38.2	64– 71 / 25.2– 28.0	–128 to +31 / –50.4 to +12.2
90	194 × 109 / 76.4 × 42.9	72– 80 / 28.3– 31.5	–144 to +35 / –56.7 to +13.8
100	215 × 121 / 84.6 × 47.6	81– 89 / 31.9– 35.0	–160 to +39 / –63.0 to +15.4
120	258 × 145 / 101.6 × 57.1	97–107 / 38.2– 42.1	–192 to +47 / –75.6 to +18.5
150	323 × 182 / 127.2 × 71.7	122–134 / 48.0– 52.8	–240 to +58 / –94.5 to +22.8
200	431 × 242 / 169.7 × 95.3	163–179 / 64.2– 70.5	–320 to +78 / –126.0 to +30.7
250	538 × 303 / 211.8 × 119.3	204–225 / 80.3– 88.6	–400 to +97 / –157.5 to +38.2
300	646 × 363 / 254.3 × 142.9	245–270 / 96.5–106.3	–480 to +116 / –189.0 to +45.7

Screen dimensions (4:3)		① Projection distance (cm/in) min. zoom–max. zoom	② Vertical shift (cm/in) lowest to highest
Diagonal (in)	W × H (cm/in)		
60	122 × 91 / 48.0 × 35.8	54– 60 / 21.3–23.6	–121 to +29 / –47.6 to +11.4
70	142 × 107 / 55.9 × 42.1	64– 70 / 25.2–27.6	–141 to +34 / –55.5 to +13.4
80	163 × 122 / 64.2 × 48.0	73– 80 / 28.7–31.5	–161 to +39 / –63.4 to +15.4
90	183 × 137 / 72.0 × 53.9	82– 91 / 32.3–35.8	–181 to +44 / –71.3 to +17.3
100	203 × 152 / 79.9 × 59.8	92–101 / 36.2–39.8	–201 to +49 / –79.1 to +19.3
120	244 × 183 / 96.1 × 72.0	110–121 / 43.3–47.6	–241 to +59 / –94.9 to +23.2
150	305 × 229 / 120.1 × 90.2	138–152 / 54.3–59.8	–302 to +73 / –118.9 to +28.7
200	406 × 305 / 159.8 × 120.1	185–203 / 72.8–79.9	–402 to +98 / –158.3 to +38.6
240	488 × 366 / 192.1 × 144.1	222–244 / 87.4–96.1	–483 to +117 / –190.2 to +46.1



**TIP** Figures are approximate, differing from the actual values by a few percent.

**Lens Shift Range: Portrait Orientation**

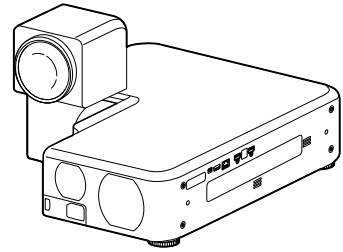
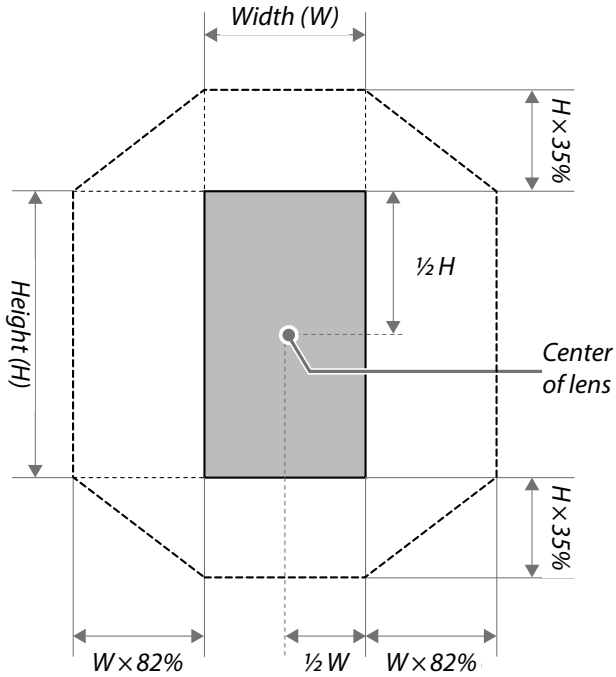

**Projection Distance**

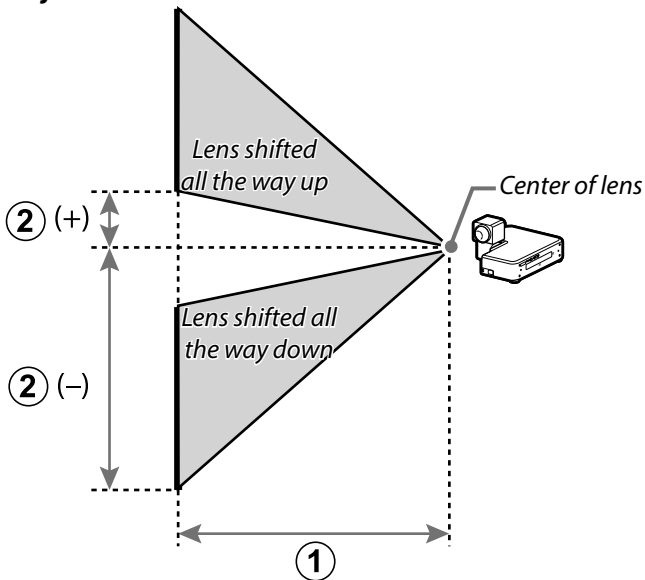

More details on projection distance are available via a simulator on the Fujifilm website:

<https://optics.fujifilm.com/projector/en/spec/>

- ① Projection distance (cm/in), minimum (projector zoomed all the way out) to maximum (projector zoomed all the way in)
- ② Vertical distance from center of lens to bottom of screen (cm/in)



**Projection Distances (Portrait Orientation)**

Screen dimensions (16:9)		① Projection distance (cm/in) min. zoom–max. zoom	② Vertical shift (cm/in) lowest to highest
Diagonal (in)	W × H (cm/in)		
70	87 × 155 / 34.3 × 61.0	52– 57 / 20.5–22.4	–132 to –23 / –52.0 to –9.1
80	100 × 177 / 39.4 × 69.7	59– 65 / 23.2–25.6	–151 to –27 / –59.4 to –10.6
90	112 × 199 / 44.1 × 78.3	67– 74 / 26.4–29.1	–169 to –30 / –66.5 to –11.8
100	125 × 221 / 49.2 × 87.0	75– 82 / 29.5–32.3	–188 to –33 / –74.0 to –13.0
120	149 × 266 / 58.7 × 104.7	90– 99 / 35.4–39.0	–226 to –40 / –89.0 to –15.7
150	187 × 332 / 73.6 × 130.7	113–124 / 44.5–48.8	–282 to –50 / –111.0 to –19.7
200	249 × 443 / 98.0 × 174.4	151–166 / 59.4–65.4	–376 to –66 / –148.0 to –26.0
250	311 × 553 / 122.4 × 217.7	189–208 / 74.4–81.9	–470 to –83 / –185.0 to –32.7
300	374 × 664 / 147.2 × 261.4	227–250 / 89.4–98.4	–565 to –100 / –222.4 to –39.4

Screen dimensions (16:10)		① Projection distance (cm/in) min. zoom–max. zoom	② Vertical shift (cm/in) lowest to highest
Diagonal (in)	W × H (cm/in)		
70	85 × 151 / 33.5 × 59.4	56– 62 / 22.0– 24.4	–134 to –17 / –52.8 to –6.7
80	97 × 172 / 38.2 × 67.7	64– 71 / 25.2– 28.0	–153 to –19 / –60.2 to –7.5
90	109 × 194 / 42.9 × 76.4	72– 80 / 28.3– 31.5	–172 to –22 / –67.7 to –8.7
100	121 × 215 / 47.6 × 84.6	81– 89 / 31.9– 35.0	–191 to –24 / –75.2 to –9.4
120	145 × 258 / 57.1 × 101.6	97–107 / 38.2– 42.1	–230 to –29 / –90.6 to –11.4
150	182 × 323 / 71.7 × 127.2	122–134 / 48.0– 52.8	–287 to –36 / –113.0 to –14.2
200	242 × 431 / 95.3 × 169.7	163–179 / 64.2– 70.5	–383 to –48 / –150.8 to –18.9
250	303 × 538 / 119.3 × 211.8	204–225 / 80.3– 88.6	–479 to –60 / –188.6 to –23.6
300	363 × 646 / 142.9 × 254.3	245–270 / 96.5–106.3	–574 to –72 / –226.0 to –28.3

Screen dimensions (4:3)		① Projection distance (cm/in) min. zoom–max. zoom	② Vertical shift (cm/in) lowest to highest
Diagonal (in)	W × H (cm/in)		
60	91 × 122 / 35.8 × 48.0	54– 60 / 21.3–23.6	–118 to –4 / –46.5 to –1.6
70	107 × 142 / 42.1 × 55.9	64– 70 / 25.2–27.6	–137 to –5 / –53.9 to –2.0
80	122 × 163 / 48.0 × 64.2	73– 80 / 28.7–31.5	–157 to –5 / –61.8 to –2.0
90	137 × 183 / 53.9 × 72.0	82– 91 / 32.3–35.8	–177 to –6 / –69.7 to –2.4
100	152 × 203 / 59.8 × 79.9	92–101 / 36.2–39.8	–196 to –7 / –77.2 to –2.8
120	183 × 244 / 72.0 × 96.1	110–121 / 43.3–47.6	–236 to –8 / –92.9 to –3.1
150	229 × 305 / 90.2 × 120.1	138–152 / 54.3–59.8	–295 to –10 / –116.1 to –3.9
200	305 × 406 / 120.1 × 159.8	185–203 / 72.8–79.9	–393 to –14 / –154.7 to –5.5
240	366 × 488 / 144.1 × 192.1	222–244 / 87.4–96.1	–471 to –16 / –185.4 to –6.3



**TIP** Figures are approximate, differing from the actual values by a few percent.

# Basic Operation

## The Control Panel

Basic operations are performed using the control panel. The names and functions of the buttons on the control panel are given below.

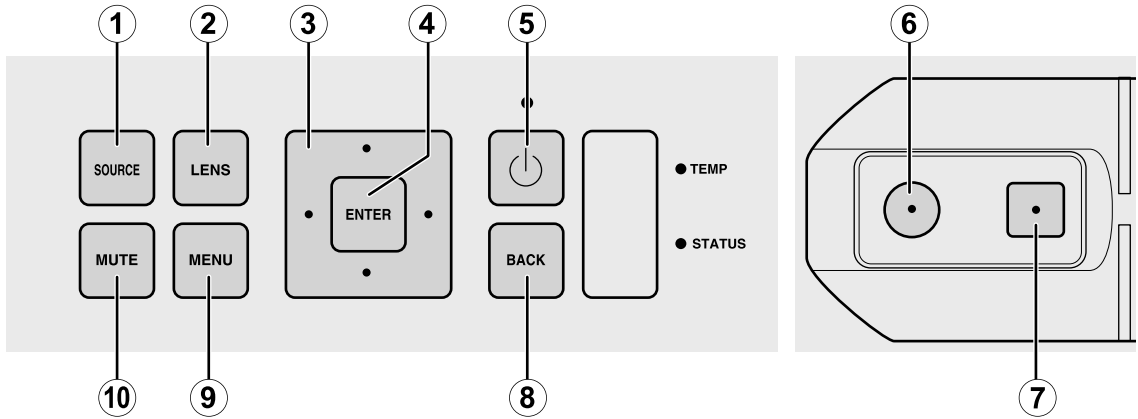

Item	Button	Function
①	<b>SOURCE</b>	Choose the input source.
②	<b>LENS</b>	Adjust lens focus, shift, and zoom.
③	Selector (▲/▼/◀/▶)	Navigate the menus.
④	<b>ENTER</b>	Select the highlighted menu item.
⑤	Power	Turn the projector on or switch it to standby.
⑥	Arm latch release	Unlatch the rotating arm.
⑦	Head latch release	Unlatch the projector head.
⑧	<b>BACK</b>	Return to the previous menu.
⑨	<b>MENU</b>	Display the menus used to adjust projector settings.
⑩	<b>MUTE</b>	Temporarily suspend projection and mute audio. Audio can be restored by pressing any other button or by pressing the <b>MUTE</b> button again.

## On/Standby

### Turning the Projector On

- 1 Connect the supplied power cable to the projector and plug it into a power outlet.

The projector will switch to standby mode.



#### CAUTION

The supplied power cable is for use exclusively with FP-Z5000 projectors. Do not use it with any other product.

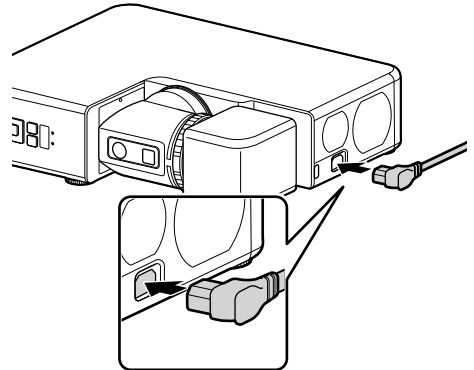

- 2 Press the power button to turn the projector on.

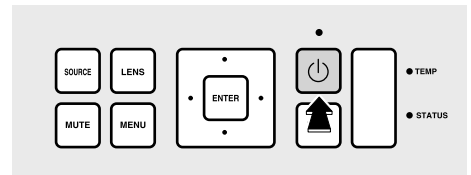

#### CAUTION

Do not look directly into the lens while the projector is on.

### Switching to Standby

Pressing the power button while the projector is on displays a confirmation dialog. Press the button again to switch the projector to standby. The cooling fan will turn off a few seconds later.



#### CAUTION

The lens latches cannot be released while the projector is on standby; check the position of the lens and replace the lens cap before switching the projector to standby.

# Projector Settings

## Rotating the Lens

To rotate the lens, release the latches by pressing the arm (①) and head (②) latch releases and then rotate the lens to the desired position. After positioning the lens, press the releases again to latch the lens in place.

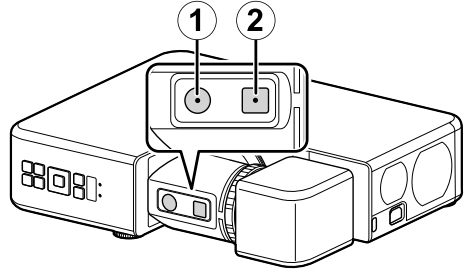

**TIPS**

- The latches will re-engage automatically if not manually re-engaged within 10 seconds.
- The LED lights when the head latch release is pressed.

## Rotating the Arm

When the arm latch is disengaged by pressing the arm latch release, the arm can be rotated 90° in the direction shown.



**TIP**

When the projector is oriented vertically, the arm can also be rotated 90° in the other direction.

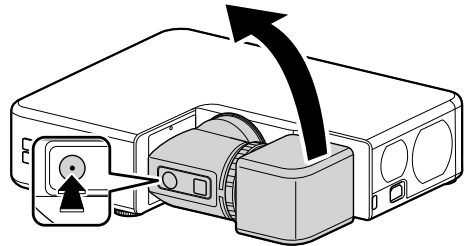

## Rotating the Projector Head

When the head latch is disengaged by pressing the head latch release, the projector head can be rotated 360° in 90° increments.

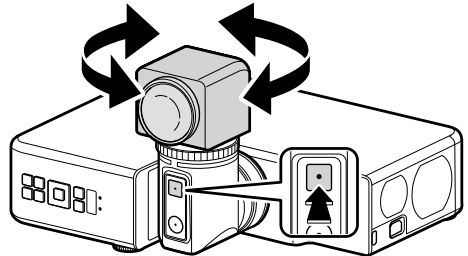

 **CAUTIONS**

- Some portions of the projected image may not be visible depending on lens shift and the orientation of the lens.
- When rotating the lens, keep it supported and rotate it slowly.
- To protect the lens, the arm locks to prevent it rotating in the direction shown when the projector head is oriented as shown in the illustration.

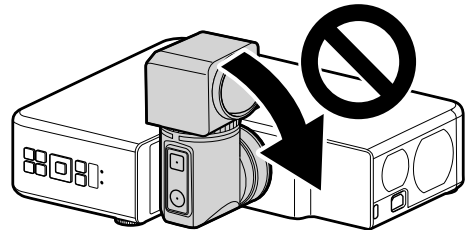

## Focus

The sharpness of the projected image can be adjusted by focusing the projector.

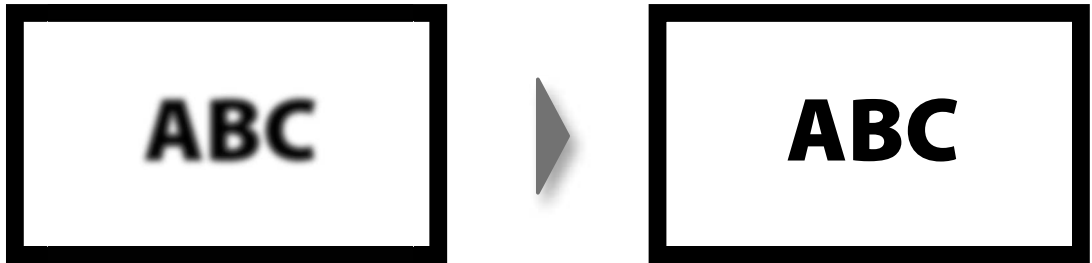

1 Press the **LENS** button until focus settings are displayed.

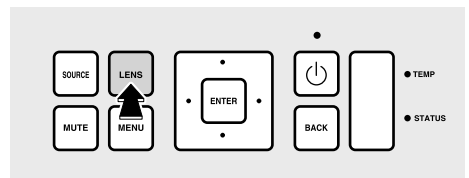

2 Adjust focus using the selector (**▲/▼/◀/▶**).

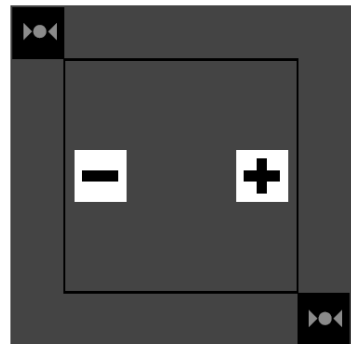

3 Press **BACK** to exit.

 **TIP** Focus can also be adjusted from the menus.

## Lens Shift

The position of the projected image can be adjusted using lens shift.

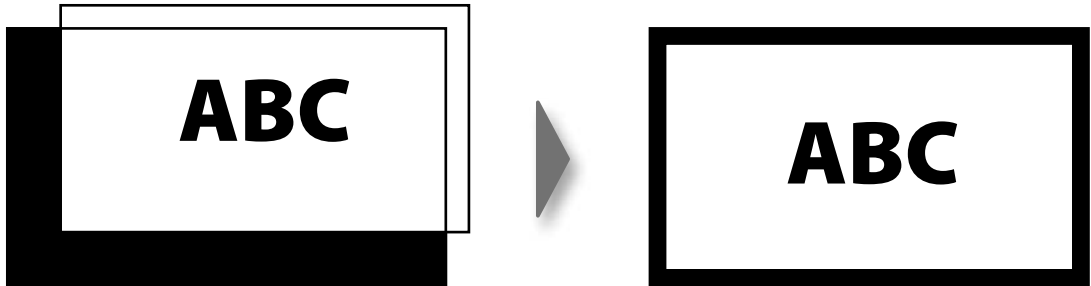

**1** Press the **LENS** button until lens shift settings are displayed.

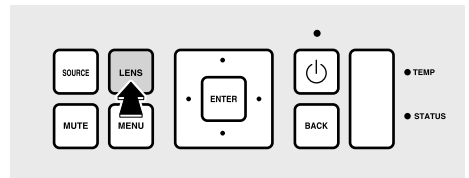

**2** Position the projected image using the selector (▲/▼/◀/▶).

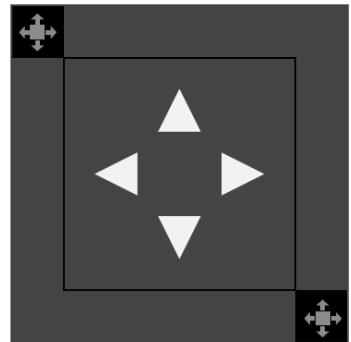

**3** Press **BACK** to exit.



### TIPS

- The selected shift position is stored when the lens is rotated.
- The previously-selected shift position is recalled when the lens latches.
- Lens shift can also be adjusted from the menus.

## Zoom

The size of the projected image can be adjusted using zoom.

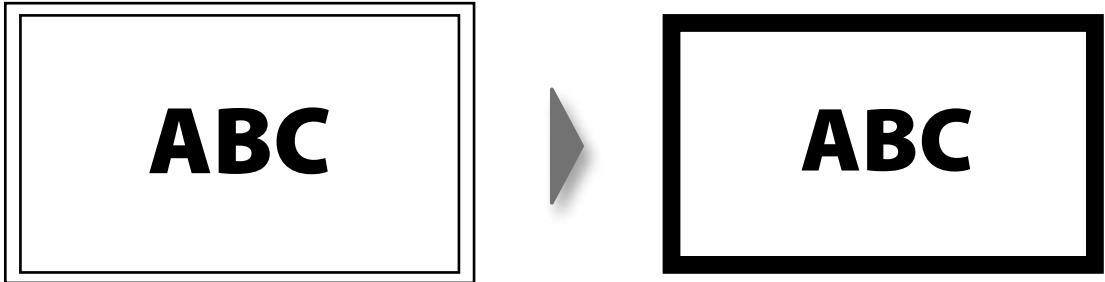

**1** Press the **LENS** button until zoom settings are displayed.

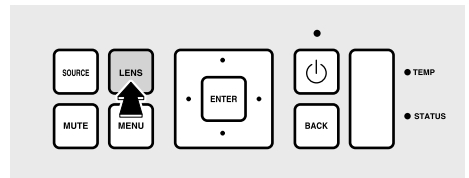

**2** Adjust the size of the projected image using the selector (▲/▼/◀/▶).

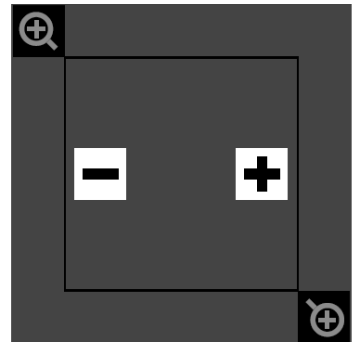

**3** Press **BACK** to exit.

 **TIP** Zoom can also be adjusted from the menus.



## Keystone Compensation

“Keystoning” (where the sides of the projected image are not parallel with the edges of the screen) can be corrected using keystone compensation.

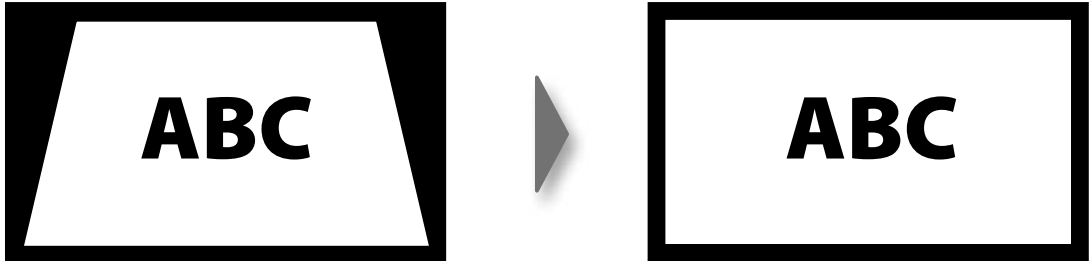

1 Press the **MENU** button to display the menus.

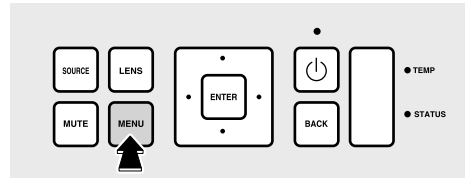

2 Highlight **Keystone** using the selector (**▲/▼**) and press **ENTER** to display keystone settings.

3 Correct keystone distortion using the selector (**▲/▼/◀/▶**).

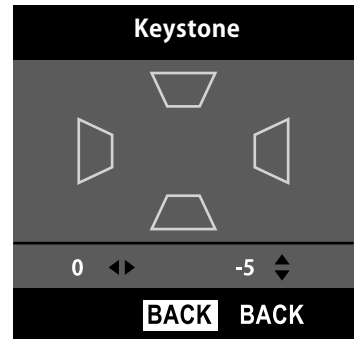

4 Press **BACK** to exit.

# Connections

## Connecting HDMI Devices

HDMI devices can be connected via the projector's HDMI 1, HDMI 2, and HDMI 3 connectors.

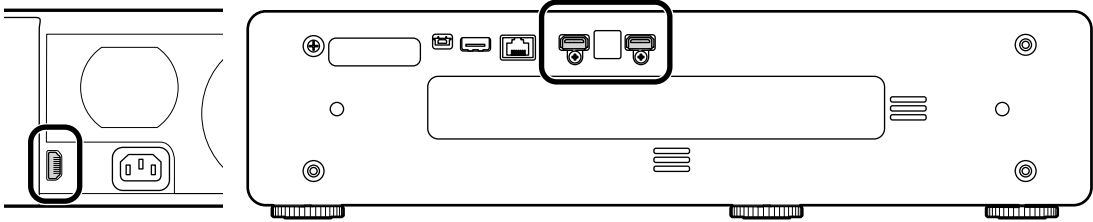

### ⚠ CAUTIONS

- Turn the HDMI device off and switch the projector to standby before connecting the cable. After connecting the cable to both devices, turn the projector on first and then turn on the HDMI device.
- Some devices require an adapter and/or a dedicated cable.



**TIP** Use the HDMI 3 connector when the projector is in vertical orientation.

## Connecting Third-Party Video Transmitters

Third-party video transmitters that support HDBaseT can be connected via the projector's HDBaseT/LAN (RJ45) connector.

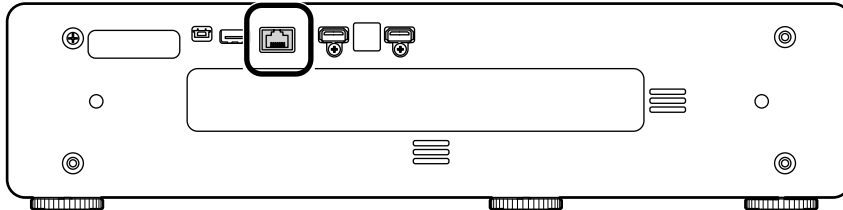

### ⚠ CAUTIONS

- Use an STP LAN cable with category 5e shielding or better.
- The maximum distance that video can be transmitted over a LAN cable is 100 m (328 ft).
- Operation is not guaranteed with all HDBaseT-compatible devices or in all operating environments.
- The projector cannot be connected directly to networks operated by mobile communications service providers, fixed-network communications service providers, Internet service providers, or other telecommunications carriers. Any connection to the Internet must be made via a router.

# Technical Notes

## Supported Resolutions

Image quality may be reduced if the resolution of the input signal exceeds the resolution of the projector's panel.

### HDMI/HDBaseT

Signal	Resolution (pixels)	Refresh rate (Hz)
VGA	640 × 480	60
SVGA	800 × 600	
XGA	1024 × 768	
WXGA	1280 × 768	
	1280 × 800	
	1366 × 768	
SXGA	1280 × 960	
	1280 × 1024	
SXGA+	1400 × 1050	
WXGA+	1440 × 900	
WSXGA+	1680 × 1050	
UXGA	1600 × 1200	
WUXGA	1920 × 1200	
SDTV (480i)	720 × 480	
SDTV (480p)	720 × 480	
SDTV (576i)	720 × 576	
SDTV (576p)	720 × 576	
HDTV (720p)	1280 × 720	
HDTV (1080i)	1920 × 1080	
HDTV (1080p)	1920 × 1080	

## The Remote Control

The names and functions of the buttons on the remote control are listed below.

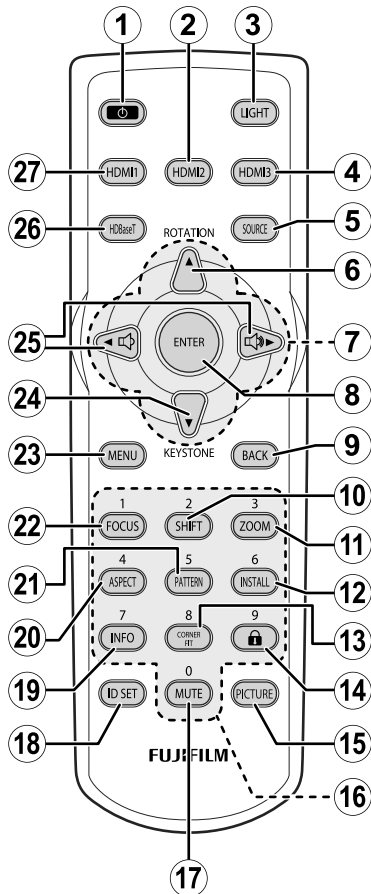

Item	Button	Function
①	Power	Turn the projector on or switch it to standby.
②	HDMI2	Select HDMI 2.
③	LIGHT	Turn the button lights on for 10 seconds.
④	HDMI3	Select HDMI 3.
⑤	SOURCE	Display input source selection options.
⑥	ROTATION	Rotate the image up or down.
⑦	Selector (▲/▼/◀/▶)	Navigate the menus.
⑧	ENTER	Select the highlighted menu item.
⑨	BACK	Return to the previous menu.
⑩	SHIFT	Adjust lens shift.
⑪	ZOOM	Adjust zoom.
⑫	INSTALL	Display projection options.
⑬	CORNER FIT	Display corner fit options.
⑭	Remote control lock	Disable the remote control. Be sure to aim the remote at the remote receiver when performing this operation.
⑮	PICTURE	Adjust settings for the projected image.
⑯	10-key pad	Use when entering the remote control ID.
⑰	MUTE	Temporarily suspend projection and mute audio. Audio can be restored by pressing any other button or by pressing the MUTE button again.
⑱	ID SET	Enter the remote control ID.
⑲	INFO	View projector information.
⑳	ASPECT	Choose the aspect ratio.
㉑	PATTERN	Display a test pattern.
㉒	FOCUS	Adjust focus.
㉓	MENU	Display the menus used to adjust projector settings.
㉔	KEYSTONE	Display keystone compensation settings.
㉕	Volume	Adjust the volume of the built-in speaker.
㉖	HDBaseT	Select HDBaseT.
㉗	HDMI 1	Select HDMI 1.

## Indicator Lamps

Projector status is shown by whether the **POWER**, **TEMP**, and **STATUS** indicator lamps are on, flashing, or off.

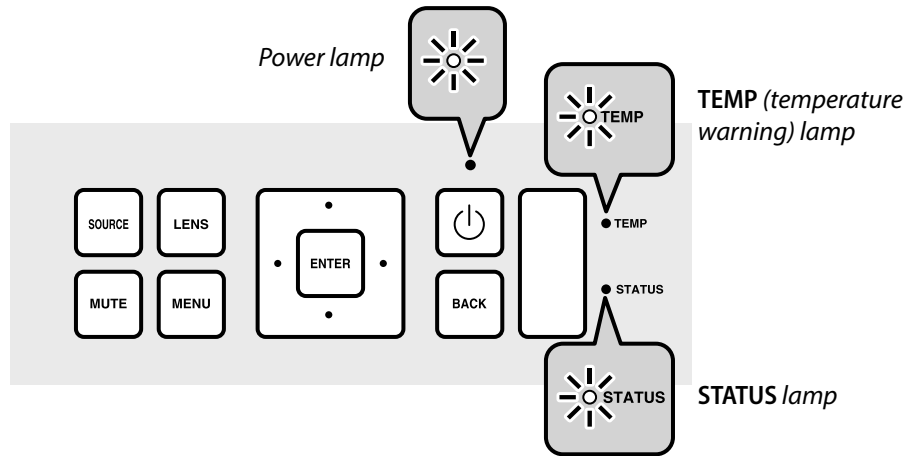

The statuses shown by the condition of the indicator lamps are listed below.

Lamp			Projector status
Power	TEMP	STATUS	
On (amber)	Off	Off	Projector in standby mode.
On (white)	Off	Off	Projector on.
On (white)	Flashing (amber)	Off	Projector temperature elevated.
On (white)	On (amber)	Off	Laser temperature elevated.
Off	Off	On (amber) or flashing (amber)	Problem with cooling fan.
On (white)			
Flashing (white)	Off	Flashing (amber)	Problem with optical engine.
Flashing (white)	Off	On (amber)	Problem with power supply.

---

# Regulatory

---

This product conforms to the following regulations related to product safety, environmental requirements and electromagnetic compatibility (EMC).

## Safety

- CSA C22.2 No. 60950-1
- UL 60950-1
- IEC 60950-1
- EN 60950-1

## Laser Safety

- IEC 60825-1
- IEC 62471
- FDA CDRH CFR 1040.10
- FDA CDRH CFR 1040.11

## Electro-Magnetic Compatibility

### Emissions

- FCC CFR47, Part 15, Subpart B/ANSI C63.4, Class A - Unintentional Radiators
- CISPR32/EN55032 Class A - Information Technology Equipment
- ICES/NMB003 (A) - Information Technology Equipment

### Immunity

- CISPR 24/EN55024 EMC Requirements - Information Technology Equipment

## Environmental

- The product conforms to:
  - EU Directive (2011/65/EU) on the restriction of the use of certain hazardous substances (RoHS) in electrical and electronic equipment and the applicable official amendment(s).
  - EU Regulation (EC) No. 1907/2006 on the registration, evaluation, authorization and restriction of chemicals (REACH) and the applicable official amendment(s).
  - EU Directive (2012/19/EU) on waste and electrical and electronic equipment (WEEE) and the applicable official amendment(s).
  - China Ministry of Information Industry Order No.39 (02/2006) on the control of pollution caused by electronic information products, the hazardous substances concentration limits (SJ/T11363-2006), and the applicable product marking requirement (SJ/T11364-2006).

## Marking

- This product conforms to all relevant Canadian, US, and European directives, standards, safety, health and environmental concerns. International packaging recycling marks conform to:
  - EU Directive (2012/19/EU) on waste and electrical and electronic equipment (WEEE).
  - EU Directive (94/62/EC) on packaging and packaging waste.
  - China packaging recycling mark standard (GB18455-2001).

---

## **Federal Communications Commission (FCC) warning**

---

- A shielded-type power cord is required in order to meet FCC emission limits and also to prevent interference to the nearby radio and television reception. It is essential that only the supplied power cord be used.
- Use only shielded signal cables to connect I/O devices to this equipment.

---

# FUJIFILM

FUJIFILM Corporation

Optical Device & Electronic Imaging Product Division  
<https://optics.fujifilm.com/projector/en/support/>



**Handle the projector correctly in accordance with the user's manual to ensure safe use.**

Warning