

Operator's Guide

Thank you for purchasing this liquid crystal projector.



WARNING • Please read the “Product Safety Guide” and this “Operator's Guide” thoroughly to ensure correct usage through understanding. After reading, store this instruction manual in a safe place for future reference.

NOTE • The information in this manual is subject to change without notice.

- The manufacturer assumes no responsibility for any errors that may appear in this manual
- The reproduction, transmission or use of this document or contents is not permitted without express written authority.

TRADEMARK ACKNOWLEDGMENT : PS/2, VGA and XGA are registered trademarks of International Business Machines Corporation. Apple, Mac and ADB are registered trademarks of Apple Computer, Inc. VESA and SVGA are trademarks of the Video Electronics Standard Association. Windows is a registered trademark of Microsoft Corporation. Carefully observe the trademarks and registered trademarks of all companies, even when not mentioned.

CONTENTS

	Page		Page
FEATURES	2	TROUBLESHOOTING	20
BEFORE USE	2	OSD Message	20
Contents of Package	2	Indicators Message	21
Part Names.....	3	Symptom	22
Loading the Batteries.....	5	SPECIFICATIONS	23
Fixing the Handle.....	5	ACCESSORIES	24
INSTALLATION	6	
Installation of the Projector and Screen.....	6	TABLES	
Angle Adjustment	6	Table 1. Installation Reference.....	6
Cabling	7	Table 2. Cabling	7
Power Connection	8	Table 3. Basic Operation	10
Example of System Setup	8	Table 4. Setup Menu	12
Plug & Play	8	Table 5. Input Menu.....	13
OPERATIONS	9	Table 6. Image Menu.....	14
Power ON	9	Table 7. Options Menu	15
Power OFF	9	Table 8. No Signal Menu	16
Basic Operation	10	Table 9. OSD Message	20
Setup Menu	12	Table 10. Indicators Message	21
Input Menu.....	13	Table 11. Symptom	22
Image Menu.....	14	Table 12. Specifications	23
Options Menu	15	
No Signal Menu	16	For "TECHNICAL" , see the end of this	
MAINTENANCE	17	manual.	
Lamp.....	17		
Air Filter	19		
Other Maintenance	19		

FEATURES

This liquid crystal projector is used to project various computer signals as well as NTSC / PAL / SECAM video signals onto a screen. Little space is required for installation and large images can easily be realized.

Outstanding Brightness

The UHB lamp and high-efficiency optical system assure a high level of brightness.

Partial Magnification Function

Interesting parts of images can be magnified for closer viewing.

Distortion Correction Function

Distortion-free images are quickly available.

Extra-low Noise Function

Acoustic noise level from the unit can be reduced.

BEFORE USE

Contents of Package

Make sure all of the following items are included in the package. If anything is missing, please contact your dealer.

NOTE • Keep the original packing material for future reshipment.

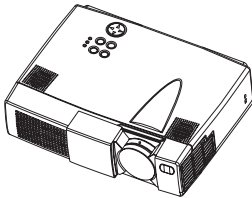

Projector



**Power Cord
(US,UK,Europe)**

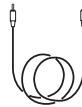

Stereo Mini Cable

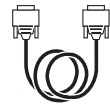

VGA Cable

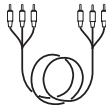

**Video/Audio Cable
(with white lead)**

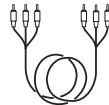

**Component
Video Cable
(with green lead)**

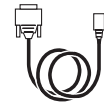

**Mouse cable
(PS/2)**

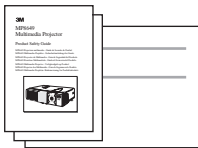

**Product Safety Guide
Warranty
Quick Start Guide**



Handle

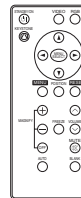

**Remote Control
containing Battery**

BEFORE USE (continued)

Part Names

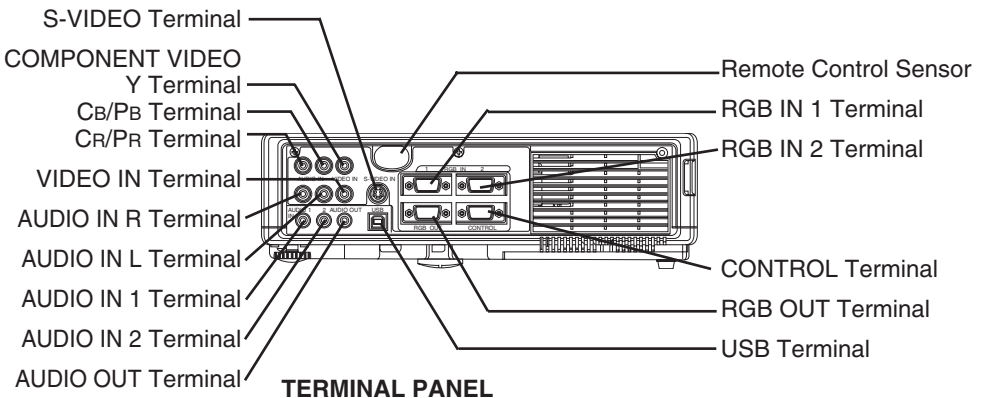
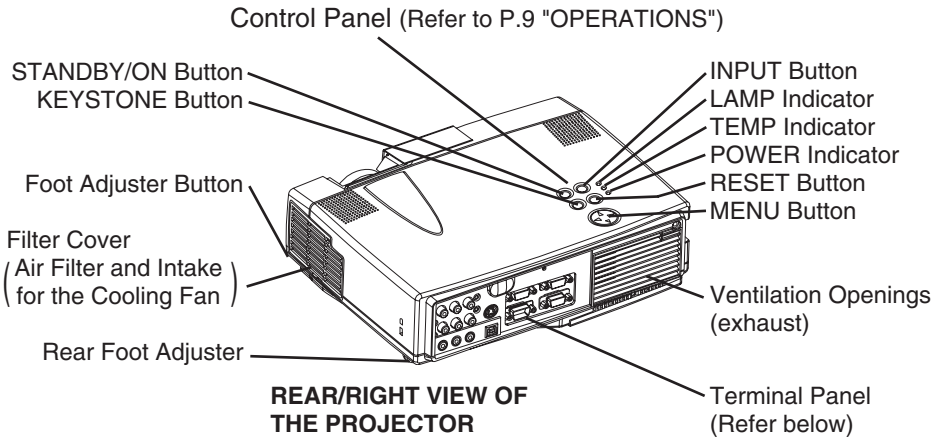
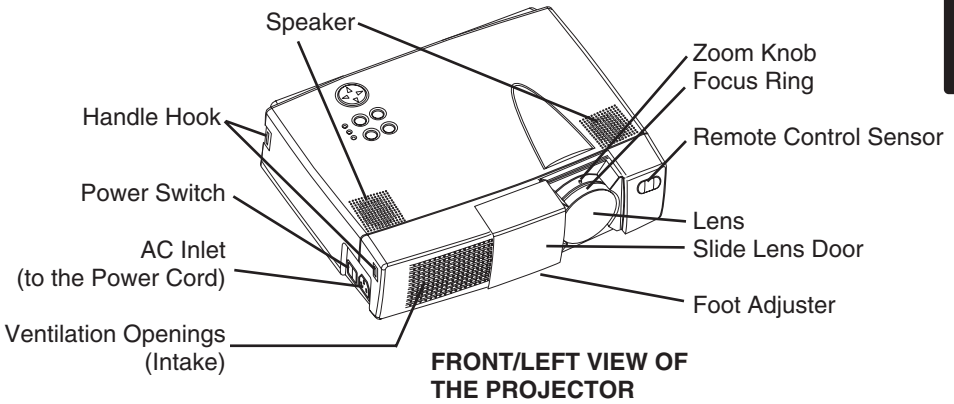

BEFORE USE (continued)

Part Names (continued)

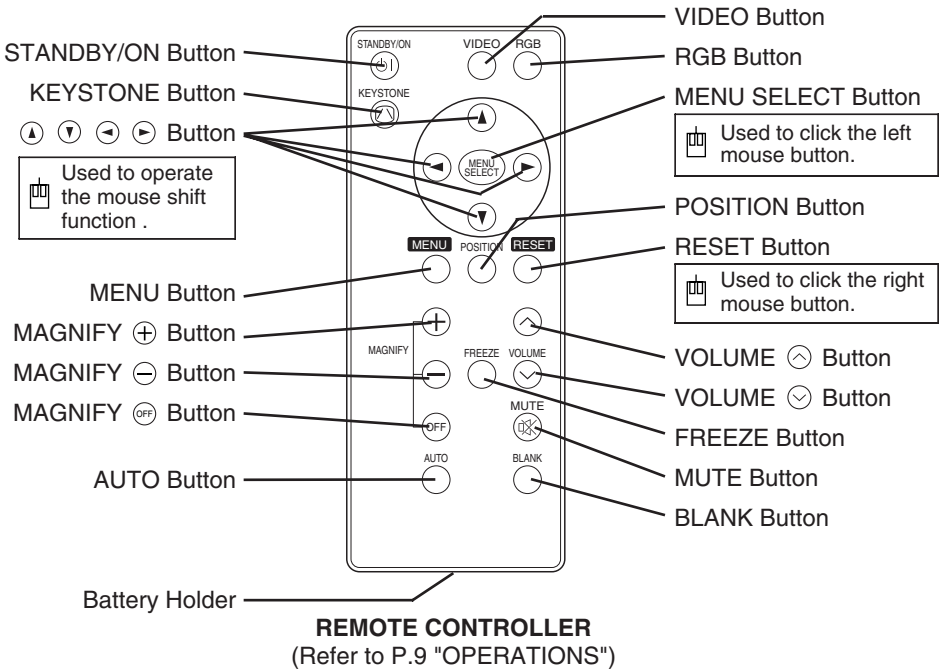

 These functions work when the mouse control function is activated. Remember, the POSITION, VOLUME, KEYSTONE, BLANK ON and MENU ON functions disable the mouse control function.

NOTE • Keep the remote control transmitter away from children and pets.

- Do not give the remote control transmitter any physical impact. Take care not to drop.
- Do not place the heavy objects on the remote control transmitter.
- Do not wet the remote control transmitter or place it on any wet object.
- Do not place the remote control transmitter close to the cooling fan of the projector.
- Do not disassemble the remote control transmitter.

BEFORE USE (continued)

Loading the Battery

First Loading:

In original packing, the battery is installed in the battery holder of the remote controller with protection film (the transparent film some of which is inside the battery folder). Pull out the protection film to load the battery.

Replacing:

1. See the reverse side of the remote controller.
2. Pinch the groove and pull out battery holder as the drawing right.
3. Remove the worn battery.
4. Install the new battery with "+" side facing.
5. Push in and click the battery holder.

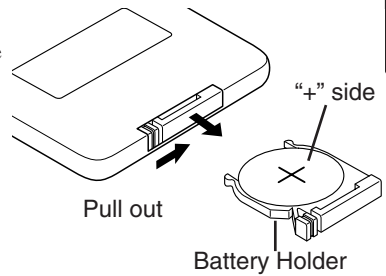

CAUTION • Incorrect handling of the battery could result in fire or personal injury.

The battery may explode if not handled properly. Be careful in handling the battery according to instructions both the "Product Safety Guide" and this manual.

- Use the 3V micro lithium battery type no.CR2025 only.
- When loading the battery, make sure the plus and minus terminals are correctly oriented as indicated in the remote controller.
- When you dispose the battery, you should obey the law in the relative area or country.
- Keep the battery away from children and pets.
- When not to be used for an extended period, remove the battery from the remote controller.

NOTE

Replace the batteries when remote control transmitter operation becomes difficult.

Fixing the Handle

Fix the enclosed handle if you need.

1. Raise up the handle hook, and pass one end of the handle through the hole of handle hook.
2. Buckle the end of the handle, as the right drawing.
3. Fix the other end of the handle to the other handle hook in the same way.

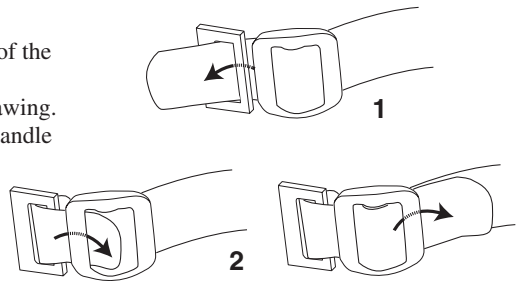

CAUTION • Make sure the handle is fixed before carrying the projector with the handle. If the projector should be dropped from the handle should be off, it could result in an injury, and continued use could result in fire or electrical shock. Do not flourish the projector with the handle.

INSTALLATION

Installation of the Projector and Screen

Refer to the drawing and table below for determining the screen size and projection distance.

The projection distances shown in the table below are for full size (800 x 600 dots).

a: Distance from the projector to the screen. ($\pm 10\%$)

Table 1. Installation Reference

Screen size [inches (m)]	a [inches (m)]	
	Min.	Max.
40 (1.0)	47 (1.2)	55 (1.4)
60 (1.5)	71 (1.8)	87 (2.2)
80 (2.0)	95 (2.4)	114 (2.9)
100 (2.5)	118 (3.0)	142 (3.6)
120 (3.0)	142 (3.6)	173 (4.4)
150 (3.8)	177 (4.5)	213 (5.4)
200 (5.0)	240 (6.1)	288 (7.3)

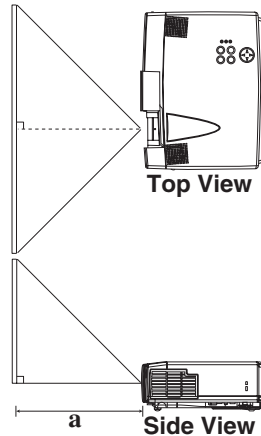

CAUTION • Install the projector in a suitable environment according to instructions of the “Product Safety Guide” and this manual.

• When you fix this unit with a metal tool and the like, you must connect it with ground wire; otherwise, fire or electric shock can result.

Connect the ground terminal of AC inlet of this unit with the ground terminal provided at the building using an optional three-core power-supply cord.

• Please basically use liquid crystal projector at the horizontal position. If you use liquid crystal projector by the lens up position, the lens down position and the side up position, this may cause the heat inside to build up and cause damage. Be especially careful not to install it with ventilation holes blocked.

• Do not install LCD projector in smoke effected environment. Smoke residue may buildup on critical parts (i.e.LCD panel, Lens Assy etc.).

Angle Adjustment

Use the foot adjusters on the bottom of the projector to adjust the projection angle. It is variable within 0° to 9° approximately.

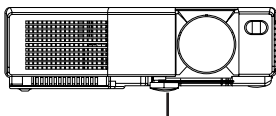

Foot Adjuster

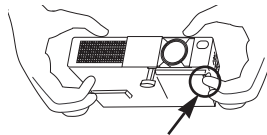

Press the foot adjuster button

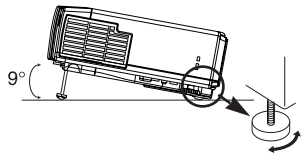

Rear Foot Adjuster

1. Lift up the front side of the projector, and pressing the foot adjuster button, adjust the projection angle.
2. Release the button to lock at the desired angle.
3. Use the rear foot adjuster to adjust the left-right slope. Do not force the foot adjuster screws. This could damage the adjusters or cause the lock to fail.



CAUTION • Do not release the foot adjuster button unless the projector is being held; otherwise, the projector could overturn or fingers could get caught and cause personal injury.

INSTALLATION (continued)

Cabling

Refer to the table below for connecting each terminal of the projector to a device.

Table 2. Cabling

Function	Terminal	Cable
RGB input	RGB IN 1	VGA cable with D-sub 15-pin shrink jack and inch thread screws
	RGB IN 2	
RGB output	RGB OUT	
Audio input (from the computer)	AUDIO IN 1 (interlocked with RGB IN 1)	Audio cable with stereo mini jack
	AUDIO IN 2 (interlocked with RGB IN 2)	
PS/2 mouse control	CONTROL	PS/2 mouse cable
ADB mouse control		ADB mouse cable
Serial mouse control		Serial mouse cable
RS-232C communication		RS-232C cable
USB mouse control	USB	USB cable
S-video input	S-VIDEO IN	S-video cable with mini DIN 4-pin jack
Video input	VIDEO IN	Video/Audio cable
Component video input	COMPONENT VIDEO Y	Component video cable
	COMPONENT VIDEO Cb/Pb	
	COMPONENT VIDEO Cr/Pr	
Audio input (from video equipment)	AUDIO IN L	Video/Audio cable or Audio cable with RCA jack
	AUDIO IN R	
Audio output	AUDIO OUT	Audio cable with stereo mini jack



CAUTION • Incorrect connecting could result in fire or electrical shock. Please read this manual and the “Product Safety Guide”.

- Before connecting, turn off to all devices to be connected, except for the USB cable.
- The cables may have to be used with the core set to the projector side. Use the cables which are included with the projector or specified.

NOTE

- Before connecting, read instruction manuals of the devices to be connected, and make sure that the projector is compatible with the device.
- Secure the screws on the connectors and tighten.
- For some RGB input modes, the optional Mac adapter is necessary.
- Some computers may have multiple display screen modes. Use of some of these modes will not be possible with this projector.
- Refer to the “TECHNICAL” section for the pin assignment of connectors and RS-232C communication data.

INSTALLATION (continued)

Power Connection

Use the correct power cord depending on the power outlet to be used.

Connect the AC inlet of the projector to the power outlet firmly by the power cord.

CAUTION • Be careful in handling the power cord according to instructions of the "Product Safety Guide" and this manual.
• Connect the power cord firmly. Avoid using a loose, unsound outlet or failed contact.

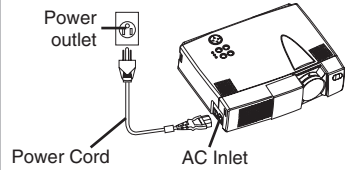

Example of System Setup

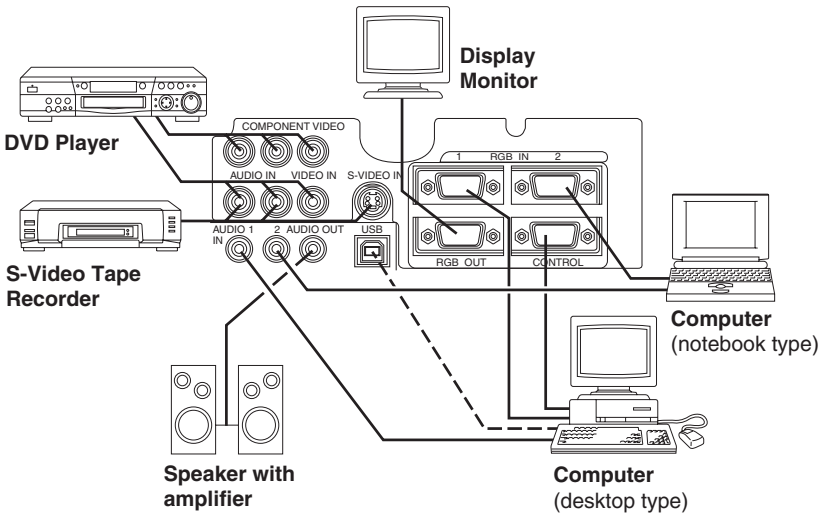

NOTE • When connecting with a notebook computer, set the proper RGB external image output (setting CRT display or simultaneous display of LCD and CRT). Please read instruction manual of the notebook for more information.

Plug & Play

This projector is VESA DDC 1/2B compatible. Plug & play is possible by connecting to a computer that is VESA DDC (Display Data Channel) compatible.

Please use this function by connecting the VGA cable with RGB IN 1 terminal (DDC 1/2B compatible). Plug & play may not operate by other connections.

NOTE • Plug & play is a system configured with peripheral equipment including a computer, display and an operating system.

- This projector is recognized as a plug & play monitor. Use the standard display drivers.
- Plug & play may not operate by the computer to connect. Use the RGB IN 2 terminal if plug & play does not operate correctly.

OPERATIONS

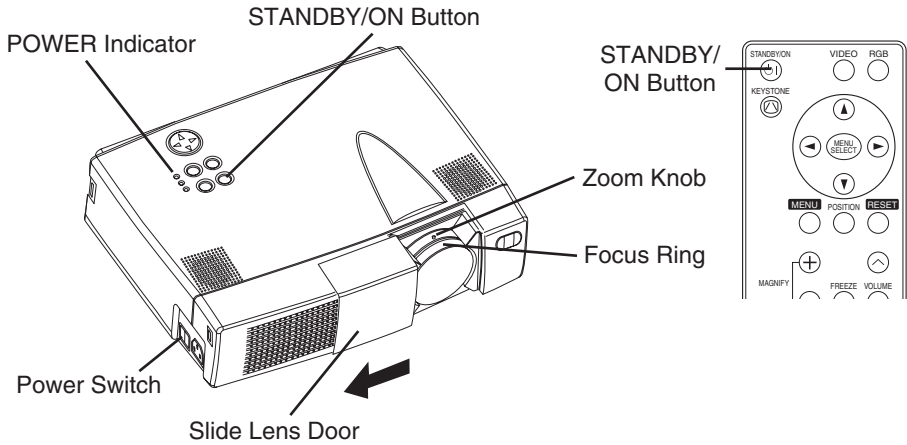

Power ON

1. Check that the power cord is connected correctly.
2. Set the power switch to [I]. The standby mode is selected, and the POWER indicator is turned to orange.
3. Press the STANDBY/ON button (Ⓜ) on the control panel or the remote control transmitter. Warm-up begins and the POWER indicator blinks in green.
4. The POWER indicator ceases blinking and turns to green when power is on. Open the slide lens door.
5. Adjust picture size using the zoom knob.
6. Adjust focus using the focus ring .

Power OFF

1. Press the STANDBY/ON button (Ⓜ) on the control panel or the remote controller. Then, the message "Power off?" will appear on the screen, and the message will disappear by any operation or no operation for 5 seconds. During this message indication, press the STANDBY/ON (Ⓜ) button again. The projector lamp is extinguished and lamp cooling begins. The POWER indicator blinks orange during lamp cooling. Pressing the STANDBY/ON button (Ⓜ) has no effect while the POWER indicator is blinking.
2. The system assumes the Standby mode when cooling is complete, and the POWER indicator ceases blinking and changes to orange. Check that the indicator is orange and set the power switch to [O].
3. The POWER indicator is extinguished when power is off. Do not forget to close the lens door.



WARNING • Please read this manual, and the "Product Safety Guide" thoroughly before using the equipment. Always ensure that the equipment is used safely.

NOTE

- Except in emergencies, follow the above-mentioned procedure for turning power off. Incorrect procedure will reduce the life of the projector lamp and LCD panel.
- To prevent any trouble, turn on/off the projector when the computer or video tape recorder is OFF. Providing a RS-232C cable is connected, turn on the computer before the projector.
- When a projector continues projecting the same image, the image may remain as an afterimage. Please do not project the image same for a long time.

OPERATIONS (continued)

Basic Operation

The basic operations shown in Table 3 is performed from the supplied remote control transmitter or the projector control panel. Items indicated by (*) may be used from the control panel.

Table 3 . Basic Operation



Item	Description
INPUT SELECT	<p>Select Input Signal (*) : Press the INPUT button. RGB IN 1→RGB IN 2→ VIDEO IN → S-VIDEO IN → COMPONENT VIDEO (→ RGB IN 1)</p> <p>Select RGB Input : Press the RGB button. VIDEO IN / S-VIDEO IN / COMPONENT VIDEO → RGB IN 1 / RGB IN 2 RGB IN 1 → RGB IN 2 (→ RGB IN 1)</p> <p>Select Video Input : Press the VIDEO button. RGB IN 1 / RGB IN 2 → VIDEO IN / S-VIDEO IN / COMPONENT VIDEO VIDEO IN → S-VIDEO IN → COMPONENT VIDEO (→ VIDEO IN)</p> <ul style="list-style-type: none"> • The selected signal name is displayed for approximately 3 seconds when the input signal is changed.
POSITION	<p>Set/Clear Position Adjustment Mode : Press the POSITION button. The [] icon is displayed in the POSITION mode.</p> <p>Image Position Adjustment: Press the ⏪, ⏩, ⏴ and ⏵ buttons in the POSITION mode.</p> <ul style="list-style-type: none"> • Valid only in the MAGNIFY mode with a video signal is input. • After approximately 10 seconds of inactivity the [] icon is extinguished and the POSITION mode is cleared automatically. • ⏪, ⏩, ⏴ and ⏵ buttons may operate as the mouse control button. Refer to page 4.
RESET (*)	<p>Initialize Each Item : Select an item and press the RESET button.</p> <p>Initialize Position Adjustment : Press the RESET button and the POSITION mode. This function is valid only when RGB signal is input.</p> <ul style="list-style-type: none"> • Valid except for the VOLUME, LANGUAGE and H PHASE. • The RESET button may operate as the mouse control button. Refer to page 4.
MAGNIFY	<p>Set MAGNIFY Mode : Press the MAGNIFY ⊕ button.</p> <p>Move Magnified Area : Run the POSITION in the MAGNIFY mode.</p> <p>Adjust Magnification : Press the MAGNIFY ⊕ / ⊖ button in MAGNIFY mode.</p> <p>Clear MAGNIFY Mode : Press the MAGNIFY ⊕ button.</p> <ul style="list-style-type: none"> • The MAGNIFY mode is cleared by running or setting the AUTO, ASPECT, INPUT SELECT or VIDEO, or by changing the input signal.
FREEZE	<p>Set/Clear FREEZE Mode : Press the FREEZE button. The [] icon is displayed, and the image is frozen, in the FREEZE mode.</p> <ul style="list-style-type: none"> • The FREEZE mode is cleared by running or setting POSITION, VOLUME, MUTE, Automatic Adjustment, BLANK ON/OFF, or MENU ON/OFF, or by changing the input signal. • Do not forget to clear frozen static images.

NOTE • Use the remote control transmitter at a distance of approximately 5m from the sensor on the front of the projector, and within a range of 30° left-right. Strong light and obstacles will interfere with operation of the remote control transmitter.

OPERATIONS (continued)

Items indicated by (*) may be used from the control panel.

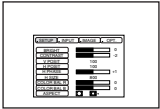
Table 3. Basic Operation (continued)

Item	Description
VOLUME	Volume Adjustment : Press the VOLUME ☺ / ☻ button.
MUTE	Set/Clear Mute Mode : Press the MUTE button. No sound is heard in the MUTE mode.
AUTO	<p>Automatic Adjustment at RGB Input : Press the AUTO button. Horizontal position(H.POSIT), vertical position (V.POSIT),clock phase (H.PHASE), and horizontal size(H.SIZE) are automatically adjusted. Use with the window at maximum size in the application display.</p> <p>Automatic Adjustment at Video Input : Press the AUTO button. A signal type appropriate for the input signal is selected automatically. Valid only when AUTO is set for VIDEO on the menu.</p> <ul style="list-style-type: none"> • This operation requires approximately 10 seconds. It may not function correctly with some input signals.
BLANK ON/OFF	Set/Clear Blank Mode : Press the BLANK button. No image is displayed in the Blank mode. The screen color is as set in BLANK on the Image menu.
MENU ON/OFF (*)	<p>Menu Display Start/Stop: Press the MENU button.</p> <ul style="list-style-type: none"> • The menu display is terminated automatically after approximately 10 seconds of inactivity.
MENU SELECT	<p>Select Menu Type: Press the MENU SELECT button. Allows the user to select the normal menu or the single menu. Only the selected item is displayed on the single menu, and other items are displayed with the ⏪ and ⏩ buttons as with the normal menu.</p> <ul style="list-style-type: none"> • Valid only when the Setup menu is used. Push the MENU SELECT button after selecting items such as "BRIGHTNESS". • The MENU SELECT button may operate as the mouse control button. Refer to page 4. <div style="display: flex; justify-content: space-around; align-items: center;"> <div style="text-align: center;"> <p>Normal menu</p>  </div> <div style="text-align: center;"> <p>(MENU SELECT)</p>  </div> <div style="text-align: center;"> <p>Single menu</p>  </div> </div>
KEYSTONE (*)	<p>Set / Clear KEYSTONE Mode : Press the KEYSTONE Ⓢ button.</p> <p>Adjust KEYSTONE : Press the ☺ / ☻ button.</p>

OPERATIONS (continued)

Setup Menu

The following adjustments and settings are possible when SETUP is selected at the top of the menu. Part of the Setup menu differs between RGB input and video input. Select an item with the \odot and \ominus buttons, and start operation. Use the Single menu to reduce menu size (see Table 3, MENU SELECT).

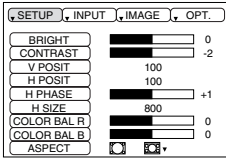

RGB

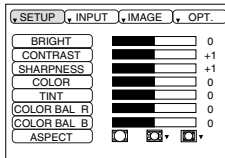

VIDEO/S-VIDEO

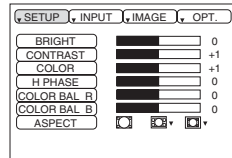

COMPONENT

Table 4. Setup Menu

Item	Description	RGB	VIDEO S-VIDEO	COMPONENT	
				480i 575i 480P	720P 1080i
BRIGHT	Dark \ominus \leftrightarrow \odot Light	✓	✓	✓	✓
CONTRAST	Weak \ominus \leftrightarrow \odot Strong	✓	✓	✓	✓
V POSIT	Down \ominus \leftrightarrow \odot Up	✓	-	-	-
H POSIT	Left \ominus \leftrightarrow \odot Right	✓	-	-	-
H PHASE	Left \ominus \leftrightarrow \odot Right • Adjust to eliminate flicker.	✓	-	✓	✓
H SIZE	Small \ominus \leftrightarrow \odot Large • The image may not be displayed correctly if the horizontal size is excessive. In such cases, press the RESET button, and initialize the horizontal size.	✓	-	-	-
SHARPNESS	Soft \ominus \leftrightarrow \odot Clear	-	✓	-	-
COLOR	Light \ominus \leftrightarrow \odot Dark	-	✓	✓	✓
TINT	Red \ominus \leftrightarrow \odot Green • Valid only when NTSC or NTSC 4.43 signal is received.	-	✓	-	-
COLOR BAL R	Light \ominus \leftrightarrow \odot Dark	✓	✓	✓	✓
COLOR BAL B	Light \ominus \leftrightarrow \odot Dark	✓	✓	✓	✓
ASPECT	Select Image Aspect Ratio : 4:3[\square] \ominus \leftrightarrow \odot 16:9[\square]	✓	-	-	✓
	Select Position of Image: Press the \uparrow button while 16:9[\square] is selected. Center \rightarrow \uparrow Down \rightarrow \uparrow Up (\rightarrow Center \uparrow)				
ASPECT	Select Image Aspect Ratio: 4:3[\square] \ominus \leftrightarrow \odot 16:9[\square] \ominus \leftrightarrow \odot 4:3small[\square]	-	✓	✓	-
	Select Position of Image : Press the \uparrow button while 16:9[\square] / 4:3 small[\square] is selected. Center \rightarrow \uparrow Down \rightarrow \uparrow Up (\rightarrow Center \uparrow) • 4:3 small may not be displayed correctly with some input signals.				

OPERATIONS (continued)

Input Menu

The following functions are available when INPUT is selected on the menu. Select an item with the \uparrow and \downarrow buttons, and start or stop operation with the \odot and \ominus buttons. The function indicated (**) are effective on video input mode only, not on RGB input mode.

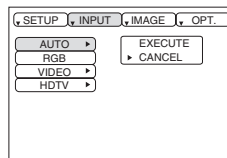

Table 5. Input Menu

Item	Description
AUTO	<p>Automatic Adjustment at RGB Input: Select the EXECUTE with the \odot button. Horizontal position (H.POSIT), vertical position (V.POSIT), clock phase (H.PHASE), and horizontal size (H.SIZE) are automatically adjusted. Use with the window at maximum size in the application display.</p> <p>Automatic Adjustment at Video Input: Select the EXECUTE with the \odot button. A signal type appropriate for the input signal is selected automatically. Valid only when AUTO is set for VIDEO on the menu.</p> <ul style="list-style-type: none"> • This operation requires approximately 10 seconds. It may not function correctly with some input signals. Pressing the AUTO button in this case may correct this problem. • This function is the same as for the AUTO function in Basic operation.
RGB	<p>Displays RGB Input Frequency: Displays the horizontal and vertical sync signal frequencies for RGB input.</p> <ul style="list-style-type: none"> • Valid only at RGB input.
VIDEO (**)	<p>Select Video Signal Type: Select the signal type with the \uparrow and \downarrow buttons. Select NTSC, PAL, SECAM, NTSC4.43, M-PAL, or N-PAL as appropriate for the input signal. The selection of AUTO enables and executes the function AUTO (Automatic Adjustment at Video Input), except for the N-PAL input.</p> <ul style="list-style-type: none"> • Use this function when the image becomes unstable (eg. the image becomes irregular, or lacks color) at VIDEO/S-VIDEO input. • Automatic Adjustment requires approximately 10 seconds. It may not function correctly with some input signals. Pressing the AUTO button in this case may correct this problem except for the N-PAL input. • For the COMPONENT VIDEO input, this function is not effective and the signal type is distinguished automatically.
HDTV	<p>Select HDTV mode: Select the 1035i mode or 1080i mode suitable for the input signal with the \uparrow / \downarrow button.</p> <ul style="list-style-type: none"> • When the selected HDTV mode is incompatible with the input signal, the image may be incorrect (eg. the display position or color is incorrect).

OPERATIONS (continued)

Image Menu

The following adjustments and settings are available when IMAGE is selected on the menu. Select an item with the \blacktriangle and \blacktriangledown buttons, and start or stop operation with the \ominus and \oplus buttons.

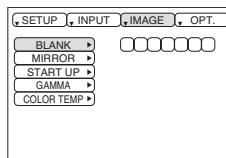

Table 6. Image Menu

Item	Description
BLANK	<p>Select Blank Screen Color: Select color with the \ominus / \oplus button.</p> <ul style="list-style-type: none"> The image is cleared and the entire screen is displayed in the selected color, when BLANK mode is set with BLANK ON, or when there is no signal for 5 minutes.
MIRROR	<p>Select Mirror Status: Select mirror status with \blacktriangle / \blacktriangledown button.</p>
START UP	<p>Setup Initial Screen Display: Select TURN ON with the \blacktriangle button.</p> <p>Clear Initial Screen Display: Select TURN OFF with the \blacktriangledown button.</p> <ul style="list-style-type: none"> Note that if TURN OFF is selected the blank screen is displayed in blue when there is no signal.
GAMMA	<p>Select Gamma mode: Select the gamma mode with the \blacktriangle / \blacktriangledown button.</p> <p>NORMAL $\blacktriangle$$\leftrightarrow$$\blacktriangledown$ CINEMA $\blacktriangle$$\leftrightarrow$$\blacktriangledown$ DYNAMIC</p>
COLOR TEMP	<p>Select Color Temperature:</p> <p>Select the color temperature mode with the \blacktriangle / \blacktriangledown button.</p> <p>NORMAL $\blacktriangle$$\leftrightarrow$$\blacktriangledown$ LOW</p>

OPERATIONS (continued)

Options Menu

The following adjustments and settings are available when OPT. is selected on the menu. Select an item with the \blacktriangle and \blacktriangledown buttons, and start or stop operation with the \ominus and \oplus buttons.

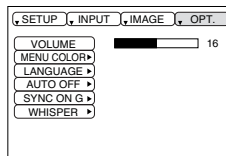

Table 7. Options Menu

Item	Description
VOLUME	Reduce \ominus \leftrightarrow \oplus Increase
MENU COLOR	Select Menu Background Color: Select with the \ominus / \oplus button.
LANGUAGE	Select Menu Display Language: Select with the \blacktriangle / \blacktriangledown button.
AUTO OFF	Set AUTO OFF: Set 1~99 minutes with the \blacktriangle / \blacktriangledown button. The system automatically enters the standby mode when a signal is not received for the set time. Clear AUTO OFF: Select STOP (0 min.) with the \blacktriangledown button. When STOP is selected the system does not enter the standby mode even if no signal is received.
SYNC ON G	SYNC ON G Valid: Select TURN ON with the \blacktriangle button. SYNC ON G Invalid: Select TURN OFF with the \blacktriangledown button. • May not be displayed correctly with some input signals when SYNC ON G is valid. In such cases, remove the signal connector so that no signal is received, set SYNC ON G to invalid, and reconnect the signal.
WHISPER	Set / Crear WHISPER Mode: Press the \blacktriangle / \blacktriangledown button. When the WHISPER is selected, the WHISPER mode is active. In the WHISPER mode, acoustic noise level from the unit is reduced, and brightness level on screen is a little lower.

OPERATIONS (continued)

No Signal Menu

The same adjustments and settings are available with the Image and Options menus when the MENU button is pressed during display of the “NO INPUT IS DETECTED ON ***” or “SYNC IS OUT OF RANGE ON ***” message while no signal is received. Select an item with the \blacktriangle and \blacktriangledown buttons, and start or stop operation with the \odot and \ominus buttons.

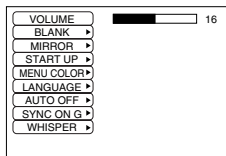

Table 8. No Signal Menu

Item	Description
VOLUME	Reduce \ominus \leftrightarrow \odot Increase <ul style="list-style-type: none"> When this function is used, audio input is automatically switched to video. The audio input can be switched by moving the DISK PAD left and right during the display of the volume adjustment bar. The volume adjustment bar is displayed by pressing VOLUME \odot / \ominus button.
BLANK	Select Blank Screen Color: Select the color with the \ominus / \odot button. <ul style="list-style-type: none"> When the blank mode is set with BLANK ON, by absence of a signal, or by input of a non-standard signal, the image is cleared and the complete screen is displayed in the selected color.
MIRROR	Select Mirror Status: Select the mirror status with the \blacktriangle / \blacktriangledown button.
START UP	Setup Initial Screen Display: Select the TURN ON with the \blacktriangle button. Clear Initial Screen Display: Select the TURN OFF with the \blacktriangledown button. <ul style="list-style-type: none"> Note that if TURN OFF is selected the blank screen is displayed in blue when there is no signal.
MENU COLOR	Select Menu Background Color: Select the color with the \ominus / \odot button.
LANGUAGE	Select Menu Display Language: Select the language with the \blacktriangle / \blacktriangledown button.
AUTO OFF	Set AUTO OFF: Set 1~99 minutes with the \blacktriangle / \blacktriangledown button. The system automatically enters the standby mode when a signal is not received for the set time. Clear AUTO OFF: Select the STOP (0 min.) with the \blacktriangledown button. When the STOP is selected the system does not enter the standby mode even if no signal is received.
SYNC ON G	SYNC ON G Valid: Select the TURN ON with the \blacktriangle button. SYNC ON G Invalid: Select the TURN OFF with the \blacktriangledown button. <ul style="list-style-type: none"> May not be displayed correctly with some input signals when the SYNC ON G is valid. In such cases, remove the signal connector so that no signal is received, set the SYNC ON G to invalid, and reconnect the signal.
WHISPER	Set / Clear WHISPER Mode: Press the \blacktriangle / \blacktriangledown button. When the WHISPER is selected, the WHISPER mode is active. In the WHISPER mode, acoustic moise level from the unit is reduced, and brightness level on screen is a little lower.

MAINTENANCE

Lamp



**HIGH VOLTAGE
HIGH TEMPERATURE
HIGH PRESSURE**

Contact your dealer before replacing the lamp.

For the optional lamp, see the item “ACCESSORIES” of P.24.

Before replacing the lamp, switch power OFF, remove the power cord from the power outlet, and wait approximately 45 minutes until the lamp has cooled. The lamp may explode if handled at high temperatures.



WARNING • For disposal of used lamp, treat according to the instruction of community authorities.

- Since the lamp is made of glass, do not apply shock to it and do not scratch it.
- Also, do not use old lamp. This could also cause explosion of the lamp.
- Premature lamp failure MAY be caused by an electronic component in the projector and not necessarily the lamp. If unsure contact your local service center.
- If it is probable that the lamp has exploded (explosive sound is heard), disconnect the power plug from the power outlet and ask your dealer to replace lamp. The lamp is covered by front glass, but in rare cases, the reflector and the inside of the projector may be damaged by scattered broken pieces of glass, and broken pieces could cause injury when being handled.
- Do not use the projector with the lamp cover removed.

Lamp

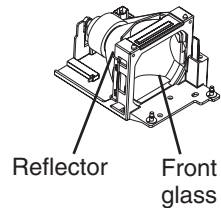

Lamp Life

Projector lamps have a finite life. The image will become darker, and hues will become weaker, after a lamp has been used for a long period of time.

Replace the lamp if the LAMP indicator is red, or the CHANGE THE LAMP message appears when the projector is switched ON. See Table 9 of P.20 and Table 10 of P.21.

NOTE • The LAMP indicator is also red when the lamp unit reaches high temperature. Before replacing the lamp, switch power OFF, wait approximately 20 minutes, and switch power ON again. If the LAMP indicator is still red, replace the lamp.

MAINTENANCE (continued)

Replacing the Lamp

1. Switch the projector OFF, remove the power cord from the power outlet, and wait at least 45 minutes for the unit to cool.
2. Prepare a new lamp.
3. Check that the projector has cooled sufficiently, and gently turn it upside down.
4. Loosen the two screws as shown in the diagram, and remove the lamp cover.
5. Loosen the three screws, and gently remove the lamp while holding the grips. Touching the inside of the lamp case may result in uneven coloring.
6. Install the new lamp and tighten the three screws firmly. Also steadily push the opposite side of the screwed lamp into the unit.
7. Replace the lamp cover in position and tighten the two screws firmly.
8. Gently turn the projector right-side up.

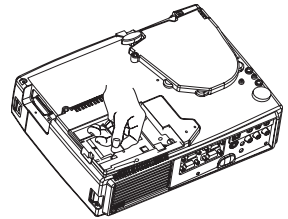
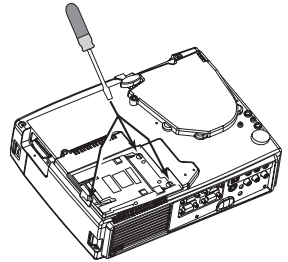
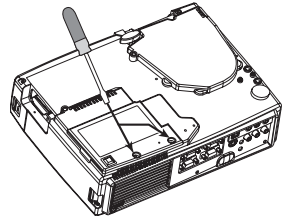

CAUTION • Ensure that screws are tightened properly. Screws not tightened fully may result in injury or accidents.
• Do not use the projector with the lamp cover removed.

Resetting the Lamp Timer

Reset the lamp timer after replacing the lamp. When the lamp has been replaced after the LAMP indicator is red, or the CHANGE THE LAMP message is displayed, complete the following operation within ten minutes of switching power ON. The power will be turned off automatically in over 10 minutes.

1. Switch power ON, and press the RESET button, for approximately three seconds. The 'LAMP xxxx hr' message will appear on the lamp timer on the bottom of the screen.
2. Press the MENU button on the remote control transmitter, or the RESET button on the control panel, while the lamp timer is displayed. The 'LAMP xxxx □ → 0 ■ CANCEL' message will then appear.
3. Press the  and select 0, and wait until the timer display is cleared.

NOTE • Do not reset the lamp timer without replacing the lamp. Reset the lamp timer always when replacing the lamp. The message functions will not operate properly if the lamp timer is not reset correctly.

MAINTENANCE (continued)

Air Filter

Cleaning the air Filter

The air filter should be cleaned as described below at intervals of approximately 100 hours.

1. Switch the projector power supply OFF, and remove the power cord from the power outlet.
2. Clean the air filter with a vacuum cleaner.

Replacing the Air Filter

Replace the air filter if contamination cannot be removed, or if it is damaged.

1. Remove the filter cover.
2. Remove the old filter.
3. Set the new filter and the filter cover.



CAUTION • Switch power OFF and remove the power cord from the power outlet before beginning maintenance work. Please read the “Product Safety Guide” thoroughly to ensure that maintenance is performed correctly.

- Replace the air filter if contamination cannot be removed, or if it is damaged. Contact your dealer in such case. For the optional air filter, see the item “ACCESSORIES” of P.24.
- Do not use the equipment with the air filter removed.
- When the air filter is clogged with dust etc. the power supply is switched OFF automatically to prevent the temperature rising inside the projector.

Other Maintenance

Maintenance Inside the Equipment

For safety reasons, ensure that the equipment is cleaned and checked by the dealer once every two years. Maintaining the equipment by yourself is dangerous.

Cleaning the Lens

Gently wipe the lens with lens cleaning paper. Do not touch the lens with your hands.

Cleaning the Cabinet and Remote control transmitter

Gently wipe with a soft cloth. If dirt and stains etc. are not easily removed, use a soft cloth dampened with water, or water and a neutral detergent, and wipe dry with a soft, dry cloth.



CAUTION • Switch power OFF and remove the power cord from the power outlet before beginning maintenance work. Please read the “Product Safety Guide” thoroughly to ensure that maintenance is performed correctly.

- Do not use detergents or chemicals other than those noted above (e.g. benzene or thinners).
- Do not use cleaning sprays.
- Do not rub with hard materials, or tap the equipment.

TROUBLESHOOTING

Service Information

For product information, product assistance, service information, or to order accessories, please call:
In U.S. or Canada :1-800-328-1371
In other locations, contact your local 3M sales office.

OSD Message

The messages as described below may appear on the screen at power ON. Take the appropriate measures when such messages appears.

Table 9. OSD Message

Message	Contents
CHANGE THE LAMP AFTER REPLACING LAMP, RESET THE LAMP TIME. (*1)	The usage time of lamp will be reaching 2000 hr shortly. (*2) It is recommended to replace the lamp soon. Prepare a new lamp as a replacement.
CHANGE THE LAMP AFTER REPLACING LAMP, RESET THE LAMP TIME. THE POWER WILL TURN OFF AFTER ** hr. (*1)	The usage time of lamp will be reaching 2000 hr shortly. It is recommended to replace the lamp within ** hours. (*2) It might be happened that the lamp is cut off before ** hr by any chance. Power will be switched OFF automatically in ** hours. Replace the lamp as shown in P.17~18 "Lamp". Always reset the lamp timer after replacing the lamp.
CHANGE THE LAMP AFTER REPLACING LAMP, RESET THE LAMP TIME. THE POWER WILL TURN OFF AFTER 0 hr.	The usage time of lamp is about to reach. Power will be switched OFF in a few minutes. (*2) Switch power OFF immediately and replace the lamp as shown in P.17 ~18 "Lamp". Always reset the lamp timer after replacing the lamp.
NO INPUT IS DETECTED ON ***	No input signal found. Check signal input connections and signal sources.
SYNC IS OUT OF RANGE ON ***	The horizontal or vertical frequency of the input signal is not within the specified range. Check the specifications of the equipment and the signal source.

NOTE (*1) This message is cleared automatically after approximately three minutes, and appears every time power is switched ON.

(*2) The unit has a function to turn the power off which will be active when the usage time reaches 2000 hr. However the life of lamp might be much different among lamps, so that it might be happened that a lamp is cut off before the function is active.

TROUBLESHOOTING (continued)

Indicators Message

The POWER indicator, LAMP indicator, and TEMP indicator are lit and blank as follows. Take the appropriate measures.

Table 10. Indicators Message

POWER indicator	LAMP indicator	TEMP indicator	Contents
Lights orange	Turns off	Turns off	The Standby mode has been set.
Blinks green	Turns off	Turns off	Warming up. Please wait.
Lights green	Turns off	Turns off	ON. Normal operation possible.
Blinks orange	Turns off	Turns off	Cooling. Please wait.
Blinks red	-	-	Cooling. Please wait. The error is found. Take the appropriate measures when the POWER indicator ceases blinking
Blinks /Lights red	Lights red	Turns off	Lamp is not lit. The interior of the equipment may be too hot. Switch power OFF, wait 20 minutes until the equipment cools, and check whether the ventilation openings are blocked, whether the air filter is dirty, or whether the ambient temperature exceeds 35 °C. And switch power ON again. Replace the lamp if the same problem occurs.
Blinks /Lights red	Blinks red	Turns off	Lamp or lamp cover is not found, or hasn't been fitted in correctly. Switch power OFF, and wait for 45 minutes until the equipment cools. Check fitting of the lamp and lamp cover, and switch power ON again. Contact your dealer if the same problem occurs again.
Blinks /Lights red	Turns off	Blinks red	The cooling fan is not operating. Switch power OFF, and wait for 20 minutes until the equipment cools. Check for foreign matters in the fan, and switch power ON again. Contact your dealer if the same problem occurs again.
Blinks /Lights red	Turns off	Lights red	The interior of the equipment is too hot. Switch power OFF, and wait for 20 minutes until the equipment cools. Check whether the ventilation openings are blocked, whether the air filter is dirty, or whether the ambient temperature exceeds 35 °C. Then switch power ON again. Contact your dealer if the same problem occurs again.
Lights green	Blinks red	Blinks red	The interior of the equipment is too cool. Check whether the ambient temperature is below 0°C. Contact your dealer if the same problem occurs when the ambient temperature is 0~35°C.

NOTE When the internal temperature becomes excessive power is switched OFF automatically for safety reasons, and the indicator is extinguished. Set the power switch to [O] and wait for 20 minutes until the equipment has cooled sufficiently.

TROUBLESHOOTING (continued)

Symptom

Before requesting repair, check in accordance with the following chart. If the situation cannot be corrected, then contact your dealer.

Table 11. Symptom

Symptom	Possible cause	Remedy	Page
The power is not turned on.	The main power switch is not turned on.	Turn on the main power switch.	8,9
	The power cord is disconnected.	Plug the power cord into an AC power outlet.	
No video or audio.	The input is not correctly set.	Use the projector or remote control transmitter to set.	10
	No signal input.	Connect correctly.	7,8
Video is present but no audio.	The projector is not correctly connected.	Connect correctly.	7,8
	The volume is set to minimum.	Press VOLUME \ominus on the remote control or display the menu screen and adjust the volume.	11,15
	Mute is turned on.	Press the MUTE M button.	11
Audio is present but no video.	The projector is not correctly connected.	Connect correctly.	7,8
	The brightness adjustment knob is rotated fully clockwise.	Select BRIGHT with the MENU button and the press the \ominus button.	12
	The lens cap is still attached.	Remove the lens cap.	9
Colors are pale and color matching is poor.	Color density and color matching are not correctly adjusted.	Adjust the video.	12
Images are dark.	Brightness and contrast are not correctly adjusted.	Adjust the video.	12
	The lamp is nearing the end of its service life.	Replace with a new lamp.	17
	WHISPER mode is set.	Clear WHISPER mode.	15
Video is blurred.	Focus or H PHASE is out of adjustment.	Adjust the focus or H PHASE.	9,12

SPECIFICATIONS

Table 12. Specifications

Item		Specification	
Product name		Liquid crystal projector	
Liquid crystal panel	Panel size	2.3 cm (0.9 type)	
	Drive system	TFT active matrix	
	Pixels	786,432 pixels (1024 horizontal x 768 vertical)	
Lens		Zoom lens F=1.7 ~ 2.1 f=27.3 ~ 32.8 mm	
Lamp		200 W UHB	
Speaker		1.0W+1.0W (stereo)	
Power supply		AC100 ~ 120V, 3.3A / AC220 ~ 240V, 1.4A	
Power consumption		310W	
Temperature range		0 ~ 35°C (Operating)	
Size		298 (W) x 94.6 (H) x 228 (D) mm	
Weight (mass)		3.25 kg	
RGB signal input	RGB IN	1	Video: Analog 0.7Vp-p, 75Ω terminator (positive) H/V. sync.: TTL level (positive/negative) Composite sync.: TTL level D-sub 15-pin shrink jack
		2	
	AUDIO IN	1	200mVrms, 50 kΩ (max. 3.0Vp-p)
		2	Stereo mini jack
Video signal input	VIDEO IN		1.0Vp-p, 75Ω terminator RCA jack
	S-VIDEO IN		Brightness signal: 1.0Vp-p, 75Ω terminator Color signal: 0.286Vp-p (NTSC, burst signal), 75Ω terminator 0.3Vp-p (PAL/SECAM, burst signal), 75Ω terminator Mini DIN 4-pin jack
	COMPONENT VIDEO	Y	1.0 Vp-p, 75 Ω Terminator (Positive)
		CB/CR	0.7 Vp-p, 75 Ω Terminator (Positive)
		PB/PR	0.7 Vp-p, 75 Ω Terminator (Positive)
	AUDIO IN	L	200mVrms, 50 kΩ (max. 3.0Vp-p)
R		RCA jack	
Signal output	RGB OUT		Video: Analog 0.7Vp-p, 75Ω output impedance (positive) H/V. sync.: TTL level (positive/negative) Composite sync.: TTL level D-sub 15-pin shrink jack
	AUDIO OUT		200mVrms, output impedance 1 kΩ (max. 3.0Vp-p) Stereo mini jack
Control functions	CONTROL		D-sub 15-pin shrink plug
	USB		USB jack (B type)

NOTE • This specifications are subject to change without notice.

ACCESSORIES

Accessories.....	Part Number
UHB Lamp, 200W	78-6969-9464-5
Air Filter	78-8118-8896-1
Power Cord (US).....	78-8118-8102-4
Power Cord (UK).....	78-8118-8101-6
Power Cord (Europe)	78-8118-8103-2
VGA Cable	78-8118-8708-8
RCA Component Cable	78-8118-8843-3
RCA Video/Audio Cable.....	78-8118-3234-0
Stereo Mini-Cable	78-8118-8846-6
Mouse Cable (PS/2)	78-8118-8105-7
Remote Control Transmitter.....	78-8118-8909-2
Handle	78-8118-8673-4

Not Included with Basic Packet.....	Part Number
Ceiling mount	78-6969-9261-5
Adjustable Height Suspension	78-6969-8312-7
Shipping Case	78-6969-9259-9
Soft Carry Case	78-6969-9207-7
S-Video Cable	78-8118-3238-1
Mouse Cable (ADB)	78-8118-8106-5
Mouse Cable (Serial)	78-8118-8107-3
Mouse Cable (USB)	78-8118-8186-7
RS-232C Control Cable	78-8118-3312-4
Mac Adapter	78-8118-3308-2

How to Order

Please order these parts through your dealer, or contact 3M Customer Service at the following number :

In U.S. or Canada : **1-800-328-1371**

In other locations,contact your local 3M sales office.