

Brookstone®

Big Shot™

ULTRA SHORT THROW SMART PROJECTOR

Brookstone assumes no responsibility for any errors that may appear in this manual. Information contained herein is subject to change without notice.

All trademarks referenced herein are the property of their respective owners.

CONTENTS

Caution	2
Warning!	5
FCC Information	6
Specifications	10
Operating the Remote	11
Pairing the Remote	11
Controls and Functions	12
Operating the Projector	14
Language	14
Date and Time	14
WiFi Connection	14
Projecting Content	15
Audio	22
Image Adjustments	24
Check Internal Storage Capacity	25
Using the Projector as a Speaker	26
Cleaning the Lens	26
Updating the Projector	27
Reset to Factory Defaults	27
Troubleshooting	28
One (1) Year Limited Warranty	32

CAUTION

- TO REDUCE THE RISK OF ELECTRIC SHOCK, DO NOT REMOVE COVER. THERE ARE NO SERVICEABLE PARTS INSIDE
- TO REDUCE THE RISK OF FIRE OR ELECTRIC SHOCK, DO NOT EXPOSE THIS UNIT TO RAIN OR MOISTURE.



The lightning flash with arrow-head symbol within an equilateral triangle is intended to alert the user to the presence of uninsulated "dangerous voltage" within the unit's enclosure that may be of sufficient magnitude to constitute a risk of electric shock



The exclamation point within an equilateral triangle is intended to alert the user to the presence of important operating and maintenance (servicing) instructions in the literature accompanying the unit.

IMPORTANT SAFETY INSTRUCTIONS

All of the safety and operating instructions should be read, adhered to and followed before the unit is operated.

SAVE THESE INSTRUCTIONS!

DANGER

To reduce the risk of electric shock, burns, fire or injury:

1. Do not use while bathing or in a shower.
2. Do not place or store unit where it can fall or be pulled into a tub or sink.
3. Do not place in, drop or submerge in water or other liquid.
4. Do not reach for unit that has fallen into water. Unplug it immediately.
5. Care should be taken so that objects do not fall and liquids are not spilled onto the unit.

WARNING

1. Close supervision is necessary when this appliance/product is used by or near children or mentally disabled individuals.
2. Use this unit only for its intended use as described in this manual.
3. Unplug this unit during lightning storms or when unused for long periods of time.
4. Never drop or insert an object into any opening.
5. Protect the adapter cord from being walked on or pinched, particularly at plug outlets, convenience receptacles and the point where it exits the unit.
6. Do not allow adapter cord to touch hot surfaces. Wrap cord loosely around the unit when storing.

7. The unit should be situated away from direct sunlight or heat sources such as radiators, electric heaters, heat registers, stoves, or other units (including amplifiers) that produce heat. Avoid placing on top of stereo equipment that radiates heat.
8. Never block the air openings of the unit with materials such as clothing, plastic bags or papers, or place it on a soft surface such as a bed or couch, where the air openings may be blocked.
9. Do not overload electrical outlet. Use only the power source as indicated.
10. Do not carry this unit by cord or use cord as handle.
11. Never operate this unit if it has a damaged cord or plug, if it is not working properly, or if it has been dropped or damaged, or dropped into water. If the unit's power supply cord or plug is damaged, do not attempt to fix it yourself.
12. To avoid the risk of electric shock, do not disassemble or attempt to repair the unit. Incorrect repair can cause risk of electric shock or injury to persons when unit is used.
13. Do not operate in the presence of explosive and/or flammable fumes.
14. Never remove the plug from the socket by pulling the power cord.
15. The device must not be co-located or operating in conjunction with any other antenna or transmitter.

WARNING!

- Do not store this product in high temperatures, damp areas, or in direct sunlight.
- Never disassemble the product.
- Never dispose of the product in fire or water, which may result in explosion and/or injury.
- Keep product out of reach of children.
- Do not touch product with damp hands.
- Dispose of the product properly.
- The product must not be discarded with ordinary household waste.
- Contact your local recycling center for proper disposal.

FCC INFORMATION

This device complies with part 15 of the FCC rules. Operation is subject to the following two conditions:

- 1) This device may not cause harmful interference, and
- 2) This device must accept any interference received including interference that may cause undesired operation.

WARNING: Changes or modifications to this unit not expressly approved by the party responsible for compliance could void the user's authority to operate the equipment.

CAUTION: To maintain compliance with the FCC's RF exposure guidelines, place the product at least 8 inches from nearby persons.

NOTE: This equipment has been tested and found to comply with the limits for a Class B digital device, pursuant to Part 15 of the FCC Rules. These limits are designed to provide reasonable protection against harmful interference in a residential installation. This unit generates, uses, and can radiate radio frequency energy and if not installed and used in accordance with the instructions, may cause harmful interference to radio communications. However, there is no guarantee that

interference will not occur in a particular installation. If this equipment does cause harmful interference to radio or television reception, which can be determined by turning the equipment off and on, the user is encouraged to try and correct the interference by one or more of the following measures:

- Reorient or relocate the receiving antenna.
- Increase the separation between the equipment and receiver.
- Connect the equipment to an outlet on a circuit different from that to which the receiver is connected.
- Consult the dealer or an experienced radio/TV technician for help.

Shielded cables must be used with this unit to ensure compliance with the Class B FCC limits.

CAUTION: The radiated output power of the Wi-Fi technology is below the FCC radio frequency exposure limits. Nevertheless, it is advised to use the wireless equipment in such a manner that the potential for human contact during normal operation is minimized.

LOCATION OF PARTS AND CONTROLS

- | | |
|--------------------|-----------------------------|
| 1. USB (5V/1A) | 5. HDMI 3 |
| 2. Bluetooth Reset | 6. 3.5mm Audio Out |
| 3. HDMI 1 | 7. Kensington Security Slot |
| 4. HDMI 2 | 8. Power port |

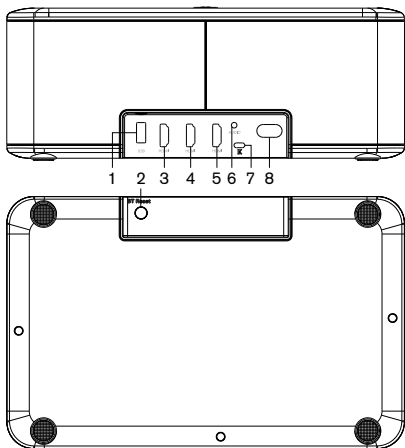

LOCATION OF PARTS AND CONTROLS

- 9. Lens
- 10. Status light
- 11. Power button

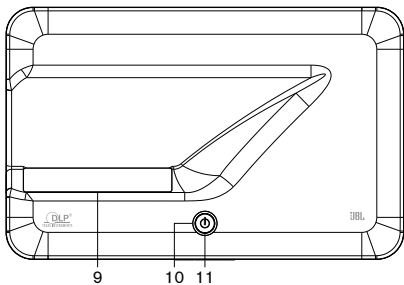

SPECIFICATIONS

Product Dimensions	10.4" x 6.6" x 3.9"
Brightness	200 Lumens
Lamp Life	LED lamp with up to 20,000 hours
Focus	Auto
Image Size	Up to 120" projected image (30" from the wall)
Min Distance	13" from projection surface (60" projected image*)
Throw Ratio	0.33
Contrast Ratio	400:1
Native Resolution	1280 x 720 (720p)
Aspect Ratio	16:9
Built-in Speakers	2 8-watt JBL speakers
Internal Memory	5GB
Wi-Fi	2.4Ghz & 5Ghz
System	Android 4.4
Keystone	Manual $\pm 10^\circ$ vertical adjustment

*All image dimensions are measured diagonally.

OPERATING THE REMOTE



PAIRING THE REMOTE

The projector is primarily controlled through the included remote. To pair the remote:

IMPORTANT: The distance between the remote and the projector should be 6.5 feet or less.

1. Plug the power cord into the projector and the other end into a wall outlet.
2. Power the projector on by pressing the on/off button on the projector. Allow the projector a moment to startup
3. Install the (2) included AAA batteries in the remote control.
 - Turn the remote control over and locate the battery door on the rear of the unit.
 - Press on the arrow on the remote door and slide in the direction indicated by the arrow.
 - Insert batteries negative (-) side first into the slots, pushing the battery into the coil and then into the compartment.

IMPORTANT: Do not insert batteries positive (+) side first.

4. Press and hold the volume up (+) and volume down (-) buttons on the remote. The red light on the remote will blink as the remote pairs with the projector.
 - When paired, the remote icon on the projector's home screen will appear blue .
 - When not paired, the remote icon on the projector's home screen will appear gray .

IMPORTANT: If pairing fails, press the Bluetooth reset button on the back of the projector and restart the pairing process.

CONTROLS AND FUNCTIONS

1. **[Status light]** Displays remote usage information
2. **[Power]** Power projector on or off
3. **[Up]** or **[Down]**, Move up or down; **[Left]** or **[Right]** Move left or right
4. **[Home]** Return to the home screen
5. **[Mouse]** Use the remote as a mouse
6. **[Volume down]** Decrease volume
7. **[Bluetooth mode]** Turns on Bluetooth speaker mode

8. **[OK]** Select a menu option
9. **[Back]** Return to the previous screen
10. **[Battery door]**
11. **[Volume up]**
Increase volume
12. Press **[Input]** to launch the input selection pop up menu. Press and hold for **[Auto Focus]** to calibrate the projector's focus.

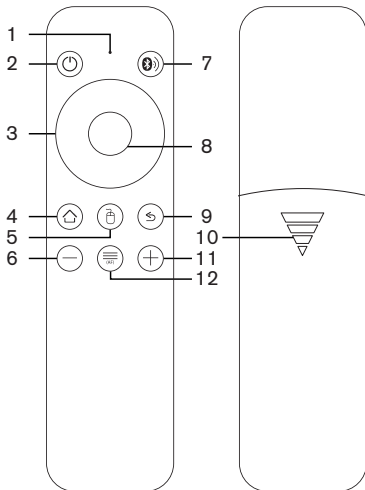

OPERATING THE PROJECTOR

LANGUAGE

1. Select "Settings"  from the projector's home screen.
2. Scroll to "About this projector" on the settings menu.
3. Select the "Language" option.
4. Scroll to the desired language and select.



DATE AND TIME

1. Select "Settings"  from the projector's home screen.
2. Scroll to "Date and Time" on the settings menu.
3. Select the desired date and time settings and format.

WIFI CONNECTION

1. Select "Settings"  from the projector's home screen.
2. Scroll to "WiFi" on the settings menu.

IMPORTANT: The "Wifi Enable" option shown at the top of the page must be turned on to see available networks.

3. Select "Scan" to search for nearby available networks.
 4. Select the desired network from the listed options.
 5. Enter any required network credentials, then select "Connect." Allow the projector and the network a few seconds to sync.
 6. Press the "Home" button on the remote to return to the projector's home screen. The wireless icon will be displayed in the projector's home screen status bar if the connection setup was successful. The number of blue shaded bars on the icon depict the strength of the wireless signal.
-  Not connected
 -  Weak wireless signal
 -  Strong wireless signal

PROJECTING CONTENT

The projector can be used as a standalone streaming device with many popular streaming applications, to share content from a variety of devices with a wired HDMI connection, to share content from smartphones or tablets with a wireless connection, or to play content from a USB flash drive.

STANDALONE STREAMING

IMPORTANT: Some apps require payment or a subscription to access content. App availability can change. Streaming speeds will vary based on your internet connection.

1. Connect the projector to a wireless network (see "WiFi Connection" on page 14).

Downloading apps

2. Select the App Center icon from the projector's home screen.
3. Select the desired app.
4. Press the "Mouse" button on the remote and select install.
5. Follow the app's on screen prompts as needed to install.
6. Select "Open" to launch the app.
7. Enter any required app access credentials.

Stream

8. From the projector's home screen, select the streaming app desired.
9. Select the content to view and play as you normally would.

TIP: To navigate and enter passwords for many apps, enable the remote's mouse mode. Mouse mode will allow the remote to show an on screen cursor, similar to a typical computer mouse. Press the "Mouse" button on the remote to turn mouse mode on or off. For mobile version Apps in the App center, long press "ok" button and then scroll the page to use it as a computer mouse.

Uninstalling Apps

1. Select "Settings"  from the projector's home screen.
2. Scroll to "Apps" on the settings menu.
3. Select the app to uninstall.
4. Select "OK."

HDMI CONNECTION

The projector can be connected to a variety of devices such as smart phones, tablets, laptops, media streamers, and digital cameras via HDMI.

IMPORTANT: Devices that do not have an HDMI port will require an adapter to connect or may need to be connected wirelessly. To determine what type of adapter you need to use, reference "What do I need to connect?" on page 19 in this manual.

1. Connect an HDMI compatible cable to the HDMI port on the projector and the other end to the source device or plug in an HDMI display dongle directly into one of the HDMI ports on the projector.
2. If you are connecting a media streamer that requires power, plug the streamer into the USB port on the projector for power (maximum USB power output 5V/1A) or into a wall outlet.

IMPORTANT: Some devices will automatically mirror the display from the source device in the projected image, other devices may not have this ability. Devices that are not able to mirror can still be used with the projector to project videos and photo slideshows.

NOTE: When connecting a laptop or computer, a multiple display option must be enabled in your display settings.

What do I need to connect?

Source Device	Needed to Connect
Apple iPad®, iPhone® and iPod touch® devices	Apple® digital AV adapter (not included) and HDMI compatible cable (included)
Android™ devices with SlimPort®	SlimPort® to HDMI adapter (not included) and HDMI compatible cable (included)
Android devices with MHL®	MHL® to HDMI adapter (not included) and HDMI compatible cable (included)
Other Android devices	Wireless HDMI adapter (not included), such as a Chromecast™
Laptop or gaming console with HDMI port, Apple TV®, ROKU®, Amazon Fire TV or other HDMI streaming devices	HDMI compatible cable (included)
HDMI streaming stick or Chromecast device	None, plugs directly into the projector's HDMI port
GoPro devices, digital cameras, and digital camcorders	Micro HDMI adapter (not included) or Mini HDMI adapter (not included) and HDMI compatible cable (included)

NOTE: If you do not see your source device listed here, contact your device manufacturer to confirm your device supports HDMI video out and what, if any, adapter is required to make the connection.

WIRELESS CONNECTION

The projector can be connected to some smart phones and tablets via a wireless connection.

Android Devices

IMPORTANT: Android devices require Android OS 4.4 or later and the wireless screen mirroring capability to connect wirelessly with the projector.

1. Press the “Input” button on the remote.
2. Select “Screen Mirroring” on the pop up menu. The projector will display a connecting screen.
3. On your Android device, swipe down from the top of the screen to display the notification panel.
4. Select the “Quick Connect” button or the “Smart View” option.
5. Select the Miroir projector from the list of available screen mirroring devices.

iOS Devices

IMPORTANT: AirPlay and wireless screen mirroring are not supported on iOS devices. Wireless iOS viewing is limited to certain file types such as native video, photos, .PPTX files, .KEY files, and .PDF files through the Brookstone Wireless Mobile Projector App.

1. Connect the projector to a wireless network (see the "WiFi Connection" on page 19 of this manual).
2. On the iOS device download and install the Brookstone Wireless Mobile Projector App.
3. Once installed, launch the app..
4. While on the projector's home screen, press the "Input" button on the remote.
5. Select DLNA on the pop up menu. The projector will automatically connect to the iOS device.

IMPORTANT: The iOS device and your projector must be on the same wireless network to establish a wireless connection with the Brookstone Wireless Mobile Projector App.

6. Select the content to project from the folders inside the

Brookstone Wireless Mobile Projector App on the iOS device.

TIP: If you don't see the content you wish to project in the folders inside the Brookstone Wireless Mobile Projector App check that the content is a compatible file type. If the file is compatible, AirDrop the file to the app.

USB FLASH DRIVE

Content can be played directly from a USB flash drive:

1. Select the "File Browser" icon from the projector's home screen.
2. Select "USB Disk" from the device list.
3. Navigate to the desired file on the USB flash drive and select the file to view.

IMPORTANT: Built in media player supports .wmv, .mpg, .mpeg, .avi, .mov, .mp4, and .jpg file types.

CHANGING CONNECTION INPUT

Press the "Input" button on the remote to launch the connection pop up menu to swap between the different HDMI inputs and the wireless input. HDMI ports in use with appear green.

AUDIO

The projector has built-in speakers that will be automatically used for sound when the projector is powered on. Optionally, connect an external speaker for bigger sound with the 3.5mm audio out port or wirelessly with a Bluetooth speaker.

CONNECTING AN EXTERNAL SPEAKER

1. Connect the external speaker to the projector's 3.5mm audio out port.
2. Select  "Settings" from the projector's home screen.
3. Scroll down to "Audio Out" on the settings menu.
4. Toggle "External Speaker" to the on position.

CONNECTING A SUBWOOFER

1. Connect the subwoofer to the projector's 3.5mm audio out port with the included RCA cable.
2. Select  "Settings" from the projector's home screen.
3. Scroll down to "Audio Out" on the settings menu.
4. Toggle "Subwoofer" to the on position.

CONNECTING A BLUETOOTH SPEAKER

1. Set the Bluetooth speaker to discoverable mode.
2. Select  "Settings" from the projector's home screen.
3. Scroll down to "Bluetooth" on the settings menu page.
4. Select "Search for devices."
5. Select your Bluetooth speaker from the list of available devices.

VOLUME ADJUSTMENTS

The volume level of the projector can be adjusted using the volume controls on the included remote control. Press the Volume up (+) button or the Volume down (-) button to adjust to the preferred volume level.

IMAGE ADJUSTMENTS

The projector will automatically adjust the image's focus.

CALIBRATE THE AUTOMATIC FOCUS ADJUSTMENT

Press and hold the Auto Focus button on the remote and allow the projector a few seconds to make the required adjustments.

MANUAL FOCUS ADJUSTMENTS

1. Select "Settings"  from the projector's home screen.
2. Scroll to "Focus" on the settings menu.
3. Select the "Manual Focus" and use the left (◀) or right (▶) buttons on the remote to adjust the focus to the desired level

MANUAL KEYSTONE ADJUSTMENT

1. Select "Settings"  from the projector's home screen.
2. Scroll to "Keystone" on the settings menu.
3. Select the "Manual Keystone" and use the left (◀) or right (▶) buttons on the remote to adjust the focus to the desired level.

VIVID MODE

Vivid mode enhances image contrast and brightness, ideal for movie watching. To turn vivid mode on or off:

1. Select the  settings icon from the projector's home screen.
2. Scroll down to the vivid mode option in the settings menu.
3. Toggle on or off.

CHECK INTERNAL STORAGE CAPACITY

1. Select "Settings"  from the projector's home screen.
2. Scroll to "Apps" on the settings menu. The internal storage capacity and free space are shown on the bar at the bottom of the screen.

USING THE PROJECTOR AS A SPEAKER

The projector's built-in internal speakers can be used as a Bluetooth speaker.

IMPORTANT: Before the projector can be used as an external speaker the remote must be paired with the projector (see "Pairing the Remote" on page 11).

1. Select the Bluetooth Audio button on the remote. The status light will flash blue to indicate the projector is ready to be paired.

IMPORTANT: If you had the projector powered on, pressing the Bluetooth Audio button will power off the projector lens.



2. On your device's Bluetooth menu, select the projector. When successfully paired, the status light on the projector will illuminate solid blue.

CLEANING THE LENS

An optical lens cleaning solution can be used to clean the projector's optical lens. Apply a small amount of the cleaning solution to a clean soft cleaning cloth and gently wipe the lens in a circular motion.

IMPORTANT: Do not apply cleaning solution directly to the lens. Do not use abrasive cleaners, solvents or cleaning cloths. Do not apply the cleaning solution to the projector's case

UPDATING THE PROJECTOR

When firmware updates are available for your projector a  red numeric indicator will appear on the home screen  system update icon. To update the firmware on your projector, select the system update icon from your projector's home screen.

RESET TO FACTORY DEFAULTS

To erase all data on the projector and reset all settings to factory defaults:

1. Select "Settings"  from the projector's home screen.

2. Scroll to "About this projector " on the settings menu.
3. Select "Factory data reset."
4. Select "Erase everything" and allow the projector a few moments to erase all the data on the projector and restart.

TROUBLESHOOTING

The projected image is blurry.

- Adjust the focus wheel on the projector to fine-tune the picture.
- Check that the surface you are projecting on is smooth.
- Check that the projector's lens is free of dust and debris.

The projected image is too small.

- Move the projector farther away from the projection surface.

The projected image is smaller on one side and larger on the other.

- Adjust the projector so the lens is facing your projection surface at a 90° angle.

The projector is not powering on.

- Check that the power cable is firmly attached to the projector's power port and the other end is securely plugged into a wall outlet.

The projector is not connecting to your wireless network.

- Check that you have selected the correct wireless router name in the setup menu.
- Check that you are inputting the correct password if your network is security enabled (passwords are case sensitive).
- Check that there are no obstructions, like cement walls, between the projector and your wireless router.
- Try relocating the projector to minimize wireless interference from other household appliances and/or other wireless networks.

You can't hear any sound.

- Check that the volume on the projector is turned up.
- If an external speaker is connected with an audio cable, check that the connection from the speaker to the projector is securely plugged in on both ends. Also check that any volume controls on the external speaker are turned up and not muted.
- If an external Bluetooth speaker is connected, check the audio settings on the projector to ensure the device is

connected properly. Also check that the Bluetooth speaker is not muted.

The projector's remote control isn't functioning.

- If the status light on the remote flashes each time you press a button on the remote, the problem is not with your remote.
- Try moving closer to the projector with the remote.
- Check that the batteries are functioning and inserted properly.

The projector is not projecting.

- Check that there are no obstructions between the projector and the projection surface.
- Power the unit off, press the restart button, and power the unit back on.
- If connected to the projector with a cabled HDMI connection:
 - Check that the HDMI compatible cable is securely plugged into the HDMI port on your device and the HDMI port on the projector.
 - Check that you are using any necessary adapters or cables to connect your device. Also check with your device manufacturer to ensure your device supports HDMI video out and you are using any required cables and/or adapters to make the connection. If an adapter is required, power down the projector, add the adapter, and then turn the projector back on.

- If connected to a laptop or computer, check your display settings to ensure a multiple display option is selected.
 - If connected to a gaming console, power down the console and the projector. Check that the HDMI compatible cable is securely connected to the HDMI port on the projector and to the HDMI port on the gaming console. Power the projector on, then power on the gaming console.
- If connected to the projector with a wireless connection to an **iOS device:**
 - Check that you have downloaded, installed and launched the Miroir Wireless app on your device.
 - Check that your projector and your iOS device are connected to the same wireless network.
 - Check that you have selected compatible content for viewing from inside the app's folders.
 - Check that the DLNA input is selected on the projector.
 - If connected to the projector with a wireless connection to an **Android device:**
 - Check that your device supports screen mirroring.
 - Check that the Screen Mirroring input is selected on the projector.

ONE (1) YEAR LIMITED WARRANTY

Brookstone® warrants this product against defects in materials and/or workmanship under normal use for a period of ONE (1) YEAR from the date of purchase by the original purchaser ("Warranty Period"). If a defect arises and a valid claim is received within the Warranty Period, at its option, Brookstone will either 1) repair the defect at no charge, using new or refurbished replacement parts, or 2) replace the product with a new product that is at least functionally equivalent to the original product, or 3) provide a store credit in the amount of the purchase price of the original product. A replacement product or part, including a user-installable part installed in accordance with instructions provided by Brookstone, assumes the remaining warranty of the original product. When a product or part is exchanged, any replacement item becomes your property and the replaced item becomes Brookstone's property. When a store credit is given, the original product must be returned to Brookstone and becomes Brookstone's property.

Obtaining Service: To obtain warranty service, call Brookstone Limited Warranty Service at 1-800-292-9819. Please be prepared to describe the product that needs service and the nature of the problem. A purchase receipt is required. All repairs and replacements must be authorized in advance. Service options, parts availability and response times will vary. You are responsible for delivery and the cost of delivery of the product or any parts to the authorized service center for replacement, per our instructions.

Limits and Exclusions: Coverage under this Limited Warranty is limited to the United States of America, including the District of Columbia and the U.S. Territories of Guam, Puerto Rico, and the U.S. Virgin Islands. This Limited Warranty applies only to products manufactured for Brookstone that can be identified by the "Brookstone" trademark, trade name, or logo affixed to them or their packaging. The Limited Warranty does

not apply to any non-Brookstone products. Manufacturers or suppliers other than Brookstone may provide their own warranties to the purchaser, but Brookstone, in so far as permitted by law, provides these products "as is." This warranty does not apply to: a) damage caused by failure to follow instructions relating to product's use or the installation of components; b) damage caused by accident, abuse, misuse, fire, floods, earthquake or other external causes; c) damage caused by service performed by anyone who is not a representative of Brookstone; d) accessories used in conjunction with a covered product; e) a product or part that has been modified to alter functionality or capability; f) items intended to be periodically replaced by the purchaser during the normal life of the product including, without limitation, batteries or light bulbs; g) any product sold "as is" including, without limitation, floor demonstration models and refurbished items; or h) a product that is used commercially or for a commercial purpose.

BROOKSTONE SHALL NOT BE LIABLE FOR INCIDENTAL OR CONSEQUENTIAL DAMAGES RESULTING FROM THE USE OF THIS PRODUCT, OR ARISING OUT OF ANY BREACH OF THIS WARRANTY. TO THE EXTENT PERMITTED BY APPLICABLE LAW, BROOKSTONE DISCLAIMS ANY AND ALL STATUTORY OR IMPLIED WARRANTIES, INCLUDING, WITHOUT LIMITATION, WARRANTIES OF MERCHANTABILITY, FITNESS FOR A PARTICULAR PURPOSE AND WARRANTIES AGAINST HIDDEN OR LATENT DEFECTS. IF BROOKSTONE CANNOT LAWFULLY DISCLAIM STATUTORY OR IMPLIED WARRANTIES, THEN TO THE EXTENT PERMITTED BY LAW, ALL SUCH WARRANTIES SHALL BE LIMITED IN DURATION TO THE DURATION OF THIS EXPRESS WARRANTY.

Some states disallow the exclusion or limitation of incidental or consequential damages or how long an implied warranty lasts, so the above exclusions or limitations may not apply to you. This warranty gives you specific legal rights and you may also have other rights, which vary from state to state. Brookstone assumes no responsibility for any errors that may appear in this manual. Information contained herein is subject to change without notice.

Find thousands more
great ideas online

Brookstone®

318490