

Panasonic

ideas for life

PT-DW5100E
PT-DW5100EL
DLP™ -Based Projector

The 5,500-lm wide projector that's easy to see
even in brightly lit rooms



5,500lm

WXGA



Further expanding reliability and picture quality

Panasonic's DLP™ system projectors have taken another step forward. Now they produce even better images while maintaining all of their highly reliable functions. Their 5,500-lm brightness delivers crisp, easy-to-see images even in brightly lit classrooms and meeting rooms, to make

presentations easier to understand. The PT-DW5100E/DW5100EL can also project wide-screen images. This allows them to project images onto a large area regardless of the ceiling height.

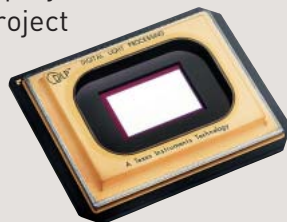

High power brightness

5,500 lm NEW

DLP™ Projector
PT-DW5100E
PT-DW5100EL*
*Without lens model



High brightness and high picture quality

Wide screen and high-power 5,500-lm brightness NEW

The PT-DW5100E/DW5100EL offers a full 5,500 lumens of brightness and WXGA wide-screen projection. A newly developed AC lamp and a more efficient reflector and synthetic mirror produce crisp, sharp images even when projecting images with a wide aspect ratio in ordinary daytime lighting.



System daylight view NEW

The system daylight view function uses an image processing circuit to compensate for the loss of colour saturation that occurs when light reflects onto the screen from bright surroundings. It is especially effective for producing crisp, sharp images in dark portions containing gradation. The function can be adjusted in three steps.



Projection of bright, high-quality images in large spaces such as halls, conference rooms, classrooms, theatres, and churches.

Conference rooms



Classrooms



Theatres



Churches



Vivid colour control

A unique control technology is used to maximise the colour segment areas of the colour wheel. Compared to conventional projectors, the brightness of each colour is increased by an average of about 15%. This results in sharper, clearer colour reproduction.

Full 10-bit picture processing NEW

The use of a full 10-bit image processing system provides smooth tonal expression. For example, skin tones appear natural and true to life.

New IP conversion circuit NEW

The PT-DW5100E/DW5100EL feature a new IP conversion circuit that produces more detailed images than our previous models.

More effective noise reduction NEW

Images are noticeably clearer, thanks to higher-performance frame noise reduction, which lowers image graininess, and improved MPEG noise reduction, which suppresses the block noise and mosquito noise that are common in fast-action scenes.

Progressive cinema scan (3/2 Pulldown)

This interlace/progressive conversion technology automatically detects when the input signal is derived from filmed material and selects the optimum progressive processing method to assure faithful reproduction of the original image.

3D colour management system

Compensation provides optimal levels of colour saturation, hue, and brightness that were not possible with conventional projectors. Colours approach those of the original image, even on large-screen displays.

Dynamic sharpness control

The dynamic sharpness control circuit adjusts the video signal waveforms based on the difference in brightness of adjacent pixels for a sharp, clear picture that is relatively unaffected by signal noise.

Excellent reliability



Dual lamp system

The use of two lamp systems increases brightness and eliminates the need to interrupt a presentation if a lamp burns out (in dual lamp operation mode).

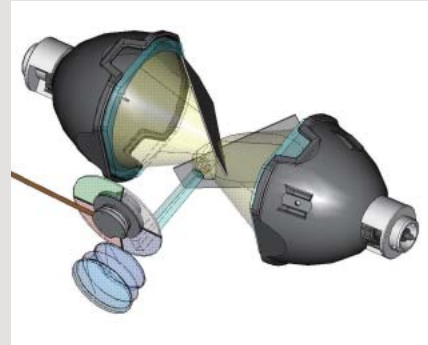

Flexible system installation

Built-in multi-screen support system

NEW

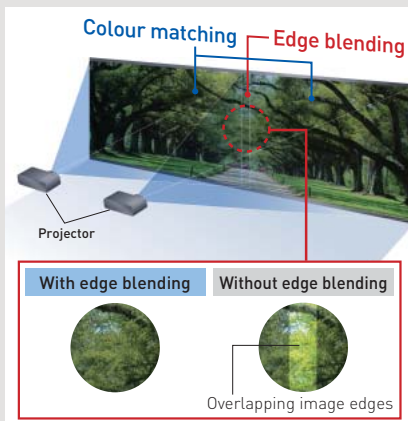

•Edge blending function

This function controls luminance at the edges where screens overlap. By eliminating unnatural screen joints, it produces uniformly attractive multi-screen displays.

•Colour matching function

The Colour Matching function corrects the subtle variations in colour reproduction between projectors. Originally developed "adjustment assist" software quickly and precisely optimises images, so the colours on each screen are uniformly reproduced.

•Digital image enlarging

Images are enlarged up to 10 times (horizontally and vertically) without having to use any additional devices.

Lens-centered design

A lens-centered, symmetrical design provides flexible system layout, eliminating the need for any special considerations when planning the installation site.

Horizontal/ Vertical lens shift

A wide adjustment range of the horizontal/vertical lens shift assures distortion free images and adds convenience and versatility. (Horizontal : manual, Vertical : powered)

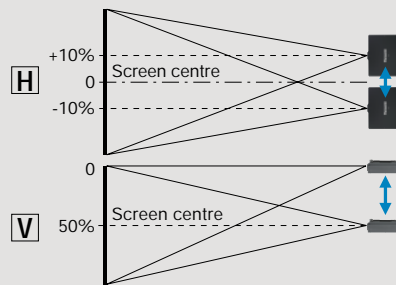

Optional lenses for various venues

Five optional lenses with different throw distances are available in addition to the supplied lens. These powered zoom/focus lenses enable the projectors to perform superbly in an array of projection environments.

Web browser control/ monitoring and e-mail message alert

Anybody can operate the PT-DW5100E/DW5100EL by remote control or monitor its status over a LAN network, because it is all done using the computer's familiar Web browser. Furthermore, the PT-DW5100E/DW5100EL sends an E-mail message to notify the operator when an error has occurred, or a lamp needs to be replaced.

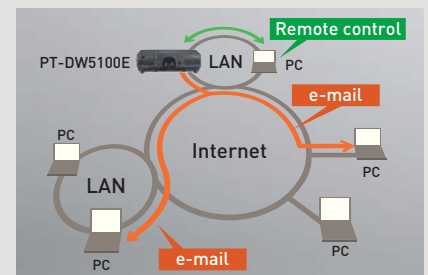
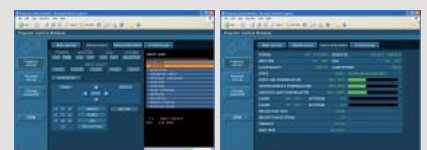

Multiple terminals

The PT-DW5100E/DW5100EL has an array of terminals—two RGB inputs including a 5-BNC connector, serial in/out, one S-video inputs, two remote in, one remote out, DVI-D and control capability—to support a broad range of projection needs HDCP. (High-Bandwidth Digital Content Protection) compliant. Using the serial terminal(RS232C), it is also possible to connect and operate AMX and Crestron control systems with ease.



AC lamp

NEW

Newly developed AC lamps with full 300 watts of power offer excellent brightness and greater reliability than other types. A new lamp drive system also lowers the stress on the lamp electrodes while the lamps are lit. The new lamps have a lifetime of approximately 3,000 hours*, which is reassuring for applications where the projector is frequently used. The AC lamps also minimise colour irregularities.

*with lamp mode: low



Liquid-cooling system

Panasonic's original liquid-cooling system directly cools the DLP™ chip, which extends PT-DW5100E/DW5100EL performance and attains a high level of reliability. It also enables operation in temperatures up to 45°C/113°F for use in a wider variety of environments, and maintains a more stable performance even in harsh conditions while keeping the operating sound down to a quiet 29 dB*.

*with lamp mode: low

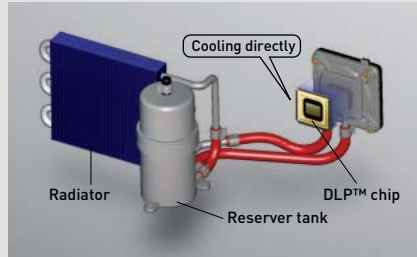

Micro cut filter

A filter in the air intake section traps dust particles that are 10 microns* or larger. By capturing approximately 7 times as much dust as conventional filters, it guards against optical blocks and reduces the penetration of dust into the interior to provide stable operation by, for example, preventing drops in brightness.

*10-micron dust = lint, pollen, etc.



Dustproof design with sealed optical block

The effect of dust has been minimised by completely sealing the optical block. The dust-free design helps ensure that this DLP™ projector will continue to deliver crisp, sharp, high-resolution images over an extended service life.

PJLink™ compatibility

The LAN terminals support PJLink™ class 1 connection. Control with the same specifications is also possible when used in a multi-projector system with projectors of another brand.

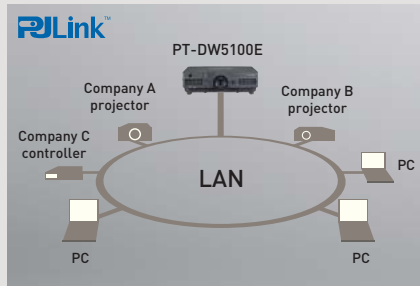

Other valuable features

Mechanical lens shutter

A mechanical lens shutter minimises annoying light leakage when the PT-DW5100E/DW5100EL is on standby or temporarily not in use, such as during a meeting.

Direct power off

Built-in capacitor provides power to cool the internal parts. This means that you can switch off the room's main power as soon as the presentation ends. PT-DW5100E/DW5100EL doesn't make you wait around and helps minimise lamp damage.

Flexible angle setting

The PT-DW5100E/DW5100EL can be rotated vertically. This means you can install it at any up-and-down angle you wish to accommodate different installation conditions.



Easy replacement of dust filter and lamp

Dust filter is replaced from the side and lamps are replaced from the back panel. Both of them are replaced very easily even when PT-DW5100E/DW5100EL is installed.

Others

- ID assignment for up to 65 units
- Coordinated group control for up to 26 groups (A-Z)
- Digital vertical keystone correction
- Built-in test pattern
- Selectable 9-language on-screen menu (English, German, French, Spanish, Italian, Russian, Japanese, Chinese, Korean)
- Anti-theft features with chain opening

Easy lens replacement

The PT-DW5100E/DW5100EL uses the bayonet system, so lenses attach and detach with one-touch ease.



Control panel and wireless remote control

NEW

The rear control panel allows for easy operation when the PT-DW5100E/DW5100EL is set on a desk or floor. New wireless remote control with longer transmission capacity of 30 m.



The PT-DW5100EL delivers the same performance as the PT-DW5100E, but comes without lens. Combine it with an optional lens to get the exact performance you need according to usage and operating conditions.

Ecology-conscious design

Panasonic works from every angle to minimise environmental impact in the product design, production and delivery processes, and in the performance of the product during its life cycle. The PT-DW5100E/DW5100EL reflects the following ecological considerations.

- No halogenated flame retardants are used in the cabinet.
- The packing case and operating manual are made from recycled paper.
- Lamp power switching further reduces power consumption.
- Auto Power Save activates standby mode when no signal is input.

Specifications

System	DLP™ Projection system
Device	0.65" (diagonal) DLP™ chip 15:9
Pixels	983,040 (1,280 x 768) x 1 total of 983,040 pixels
Lamp	300 W UHM™ lamp x 2 (Dual Lamp System)
Brightness (normal lamp)	5,500 lumens (dual lamp, high power mode)
Contrast ratio	2,000:1 (full on/full off, contrast mode: high)
Resolution	
RGB	1,280 x 768 pixels
Video	560 TV lines
Lens	
PT-DW5100E	Powered zoom/focus lens, Supplied lens: (2.0-2.6:1) F = 1.7-2.0, f = 25.6-33.8 mm
PT-DW5100EL	Optional powered zoom/focus lenses
Screen size	50 - 600 inches
Lens shift	Vertical (powered), horizontal (manual)
RGB input scanning frequency	fr 15-91 kHz, fv 50-85 Hz Dot clock 150 MHz or lower
Component signal	480i, 480p, 576i, 576p, 720/60p, 720/50p, 1080/60i, 1080/60p 1080/50i, 1080/50p
Video signal	NTSC, NTSC4.43, PAL, PAL60, PAL-N, PAL-M, SECAM
Terminals	
VIDEO IN	BNC
S-VIDEO IN	Mini DIN 4-pin
RGB1/Y/PbPr IN	BNC x 5
RGB2 IN	D-sub HD 15-pin
DVI-D IN	24pin DVI 1.0 compliant, HDCP compatible, for single link
RS-232C IN	D-sub 9-pin female
RS-232C OUT	D-sub 9-pin male
REMOTE 1 IN	M3 jack
REMOTE 1 OUT	M3 jack
REMOTE 2 IN	D-sub 9-pin female (parallel)
LAN	RJ-45x1, compliant with PLink™ (class 1), 10Base-T/100Base-TX
Keystone correction range	±30° (with standard lens)
Installation	Front/rear, ceiling/floor
Power cord length	3.0m (9.9')
Power supply	220-240 V AC, 50 / 60 Hz
Power consumption	750 W (790 VA) (15 W during standby mode with fan stopped)
Dimensions (W x H x D)	530 x 167 x 429 mm (20-7/8' x 6-9/16' x 16-7/8') (without lens)
Weight	
PT-DW5100E	13.9 kg (30.6 lbs) with supplied lens
PT-DW5100EL	13.1 kg (28.9 lbs) without lens
Operating temperature	0 - 45 °C (32 - 113 °F)
Operating humidity	20-80% (no condensation)
Supplied accessories	Power cord, Wireless/wired remote control unit, AA Batteries (x 2) for remote control

Dimensions

unit: mm [inch]

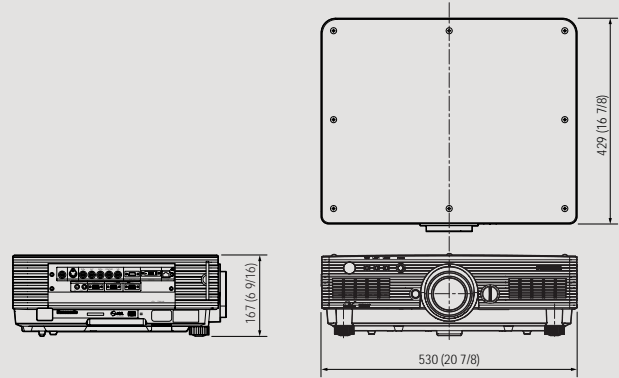

Optional accessories

Replacement Lamp Unit
ET-LAD57
ET-LAD57W (twin pack)



Zoom Lens (1.4-2.0:1)
ET-DLE100
 Zoom Lens (2.7-4.4:1)
ET-DLE200
 Zoom Lens (3.8-5.0:1)
ET-DLE310
 Zoom Lens (5.1-9.5:1)
ET-DLE410
 Fixed Focus Lens (0.9:1)
ET-DLE050



Ceiling Mount Bracket
 for high ceiling
ET-PKD56H

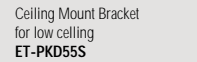

Ceiling Mount Bracket
 for low ceiling
ET-PKD55S

NOTES ON USE

Notes on Projector Placement and Operation:

The projector uses a high-wattage lamp that becomes very hot during operation. Please observe the following precautions.

- Never place objects on top of the projector while it is operating.
- Make sure there is an unobstructed space of 500 mm or more around the projector's exhaust openings.
- Do not stack projector units directly on top of one another. If two units must be stacked for backup use in ordinary projection, use a method as shown below and provide ample space between the units to ensure that exhaust heat does not accumulate near the intake opening or around the units. Dual stacked projection of the PT-DW5100E/DW5100EL is not recommended.
- If the projector is placed in a box or enclosure, ensure the temperature of the air surrounding the projector is between 0 °C/32 °F and 40 °C/104 °F*. Also make sure the projector's intake and exhaust openings are not blocked. Take particular care to ensure that hot air from the exhaust openings is not sucked into the intake openings.

* Even when the ambient temperature near the intake opening is 40 °C/104 °F or lower, an accumulation of hot air inside the cabinet may cause the protective circuit to activate and shut down the projector. Please give ample consideration to the design with regard to ambient temperature conditions.

Operating the Projector Continuously:

- If the projector is to be operated continuously 24 hours a day, use the dual-lamp optical system's alternating lamp operation (lamp changer) function. The projector cannot be operated continuously 24 hours a day in dual-lamp mode. Allow a minimum of two hours per day of non-operation time per day if the using the dual-lamp mode.
- The lamp replacement cycle duration becomes shorter if the projector is operated repeatedly for short periods.

- The projector uses a high-voltage mercury lamp that contains high internal pressure. This lamp may break, emitting a large sound, or fail to illuminate, due to impact or extended use. The length of time that it takes for the lamp to break or fail to illuminate varies greatly depending on individual lamp characteristics and usage conditions.
- The brightness of the lamp will gradually decrease with use.

Projection distance [meters/feet]

Diagonal image size	Throw distance												
	With ET-DLE050 0.9:1		With ET-DLE100 1.4-2.0:1		With supplied lens* 1.9-2.6:1		With ET-DLE200 2.7-4.4:1		With ET-DLE310 3.8-5.0:1		With ET-DLE410 5.1-9.5:1		
	L	min.	max.	min.	max.	min.	max.	min.	max.	min.	max.	min.	max.
50"	0.8m 2.8	1.4m 4.8	2.0m 6.5	1.9m 6.4	2.6m 8.6	2.7m 8.9	4.4m 14.6	3.8m 12.7	5.1m 16.7	5.1m 16.9	9.7m 32.0		
80"	1.4m 4.6	2.3m 7.8	3.2m 10.6	3.2m 10.5	4.2m 13.9	4.3m 14.3	7.2m 23.6	6.2m 20.6	8.2m 27.0	8.3m 27.3	15.7m 51.5		
100"	1.7m 5.8	3.0m 9.8	4.0m 13.3	4.0m 13.2	5.3m 17.4	5.4m 18.0	9.0m 29.6	7.8m 25.8	10.3m 33.8	10.4m 34.3	19.6m 64.6		
150"	2.7m 8.8	4.5m 14.8	6.1m 20.0	6.0m 19.9	8.0m 26.3	8.2m 27.1	13.5m 44.5	11.8m 38.9	15.5m 50.9	15.7m 51.7	29.6m 97.1		
200"	3.6m 11.8	6.0m 19.8	8.1m 26.8	8.1m 26.6	10.7m 35.1	11.0m 36.2	18.1m 59.4	15.8m 52.0	20.7m 68.0	21.0m 69.1	39.5m 129.6		
300"	—	9.1m 29.8	12.2m 40.2	12.2m 40.0	16.1m 52.8	16.6m 54.4	27.2m 89.3	23.8m 78.2	31.1m 102.2	31.6m 103.9	59.3m 194.6		
400"	—	12.1m 39.8	16.3m 53.7	16.3m 53.4	21.5m 70.5	22.1m 72.7	36.3m 119.1	31.8m 104.4	41.6m 136.5	42.3m 138.7	79.1m 259.7		
500"	—	15.2m 49.8	20.5m 67.2	20.3m 66.8	26.8m 88.1	27.7m 90.9	45.4m 148.9	39.8m 130.6	52.0m 170.7	52.9m 173.5	99.0m 324.7		
600"	—	18.2m 59.8	24.6m 80.7	24.4m 80.2	32.2m 105.8	33.2m 109.2	54.5m 178.8	47.8m 156.8	62.4m 204.9	63.5m 208.3	118.8m 389.8		

* The supplied lens is used only for PT-DW5100E.

For more information about Panasonic projectors. Visit —
 ➤➤➤ <http://panasonic.co.jp/pavc/global/projector/>

Please contact Panasonic or your dealer for a demonstration.

Panasonic



JQA-1617



RE 009



051

Weights and dimensions shown are approximate. Specifications are subject to change without notice. This product may be subject to export regulations. An application has been filed for trademark rights, or trademark rights have been granted, for PLink in Japan, United States of America and other countries and area. UHM is trademark of Matsushita Electric Industrial Co., Ltd. VGA and XGA are trademarks of International Business Machines Corporation. All other trademarks are the property of their respective trademark owners. Projection images simulated. DLP, DLP logo and DLP Medallion logo are trademarks or registered trademarks of Texas Instruments. (C) 2007 Matsushita Electric Industrial Co., Ltd. All rights reserved. PT-DW5100E1-07MAY70K Printed in Japan.